

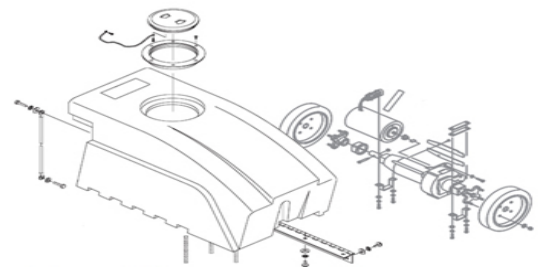

7100

Operator Manual

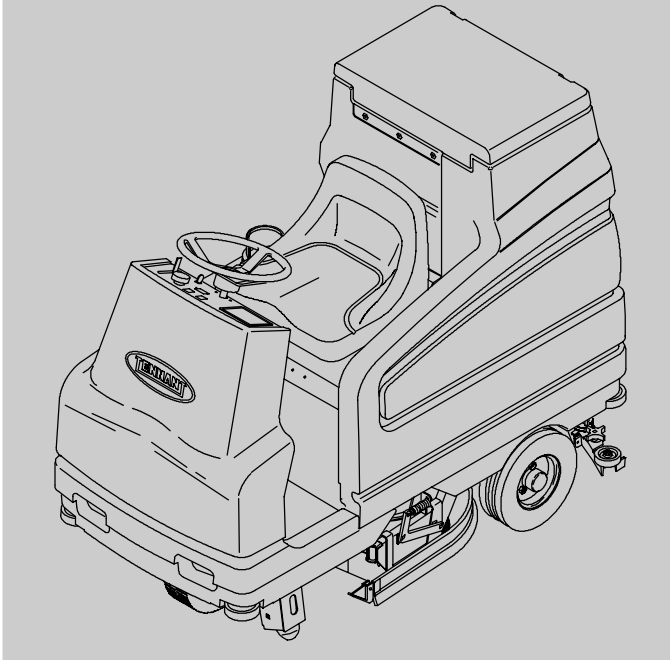

FLOOREQUIPMENTPARTS.COM



The safe scrubbing alternative®



This manual is furnished with each new TENNANT Model 7100. It provides necessary operating and preventive maintenance instructions. Read this manual completely and understand the machine before operating or servicing it.

This machine will provide excellent service. However, the best results will be obtained at minimum costs if:

- The machine is operated with reasonable care.
- The machine is maintained regularly - per the maintenance instructions provided.
- The machine is maintained with manufacturer supplied or equivalent parts.



PROTECT THE ENVIRONMENT

Please dispose of packaging materials, old machine components such as batteries, hazardous fluids such as antifreeze and oil, in a safe environmentally way according to your local waste disposal regulations.



Always remember to recycle.

MACHINE DATA

IMPORTANT: To ensure full warranty protection, fill out the MACHINE INSTALLATION / WARRANTY REPORT REPLY CARD, attached to the Parts Manual, and return to Tennant within 30 days of purchase.

Please fill out at time of installation for future reference.

Model No. - 7100

Serial No. - _____

Machine Options - _____

Sales Rep. - _____

Sales Rep. phone no. - _____

Customer Number - _____

Installation Date - _____

Tennant Company

PO Box 1452

Minneapolis, MN 55440

Phone: (800) 553-8033 or (763) 513-2850

www.tennantco.com

The Tennant logo, the FaST Foam Scrubbing Technology logo, and the "The safe scrubbing alternative" tag line are registered United States trademarks of Tennant Company.

Specifications and parts are subject to change without notice.

Copyright ©2000, 2002, 2004, 2005 Tennant, Printed in U.S.A.

CONTENTS

	Page		Page
SAFETY PRECAUTIONS	3	MAINTENANCE	52
OPERATION	5	MAINTENANCE CHART	53
OPERATOR RESPONSIBILITY	5	LUBRICATION	54
MACHINE COMPONENTS	6	STEERING CASTER PIVOT BEARING	54
CONTROL PANEL SYMBOLS	7	REAR SQUEEGEE CASTERS	54
CONTROLS AND INSTRUMENTS	8	STEERING GEAR CHAIN	54
OPERATION OF CONTROLS	9	SCRUB HEAD LIFT BEARINGS (OPTION)	55
BRAKE PEDAL	9	BATTERIES	55
PARKING BRAKE PEDAL	9	CHARGING THE BATTERIES	57
DIRECTIONAL PEDAL	9	SELF-DIAGNOSTIC TEST	58
STEERING WHEEL	10	ELECTRIC MOTORS	60
ON-OFF KEY SWITCH	11	SCRUB BRUSHES AND PADS	60
POWER KILL SWITCH	11	DISK BRUSHES	60
HOURMETER	11	REPLACING THE DISK BRUSHES OR PADS	61
OPERATING LIGHTS SWITCH	12	CYLINDRICAL BRUSHES	64
POWER WAND SWITCH (OPTION) ..	12	CHECKING AND ADJUSTING CYLINDRICAL BRUSH PATTERN ..	64
HORN BUTTON	12	REPLACING THE CYLINDRICAL BRUSHES	67
SCRUB SWITCH	13	SOLUTION SYSTEM	68
REAR SQUEEGEE SWITCH	14	RECOVERY TANK	68
ES™ SWITCH (OPTION)	14	SOLUTION TANK	69
FaST™ SWITCH (OPTION)	15	FaST™ SYSTEM (OPTION)	70
SOLUTION TANK EMPTY INDICATOR	15	REAR SQUEEGEE ASSEMBLY	71
RECOVERY TANK FULL INDICATOR .	15	REMOVING THE REAR SQUEEGEE ASSEMBLY	71
BATTERY DISCHARGE INDICATOR .	16	REPLACING THE REAR SQUEEGEE ASSEMBLY	72
CIRCUIT BREAKERS	17	LEVELING THE REAR SQUEEGEE ..	72
FUSE	17	ADJUSTING REAR SQUEEGEE BLADE DEFLECTION	73
SOLUTION FLOW LEVER	18	ADJUSTING THE SQUEEGEE GUIDE ROLLER	74
OPERATOR SEAT	18	REAR SQUEEGEE BLADES	74
SEAT SUPPORT ARM	18	REPLACING OR ROTATING THE REAR SQUEEGEE BLADE	74
SQUEEGEE WHEEL CAMS	19	REPLACING OR ROTATING THE FRONT SQUEEGEE BLADE	76
SQUEEGEE LEVELING KNOB	19	SIDE SQUEEGEE BLADES	77
HOW THE MACHINE WORKS	20	REPLACING SIDE SQUEEGEE BLADES	77
FaST™ SCRUBBING SYSTEM (OPTION)	21	BELTS AND CHAINS	78
PRE-OPERATION CHECKLIST	22	BRUSH DRIVE BELTS	78
INSTALLING FaST™ PAK AGENT (OPTION)	23	STATIC DRAG CHAIN	78
STARTING THE MACHINE	24	STEERING GEAR CHAIN	78
FILLING THE TANKS	25		
SCRUBBING AND BRUSH INFORMATION	27		
SCRUBBING	29		
DOUBLE SCRUBBING	31		
OPERATION ON INCLINES	31		
STOP SCRUBBING	32		
DRAINING AND CLEANING THE TANKS	33		
STOP THE MACHINE	38		
POST-OPERATION CHECKLIST	39		
OPTIONS	40		
POWER WAND	40		
ROLLOUT BATTERY	45		
QUICK MOP™	49		
MACHINE TROUBLESHOOTING	51		

CONTENTS

	Page
SKIRTS AND SEALS	79
SCRUB HEAD FLOOR SKIRTS	79
VACUUM FAN SEAL	79
SOLUTION TANK SEAL	80
RECOVERY TANK SEAL	80
BRAKES AND TIRES	81
BRAKES	81
BRAKE ADJUSTMENT:	81
TIRES	82
PUSHING, TOWING, AND TRANSPORTING	
THE MACHINE	83
PUSHING OR TOWING THE MACHINE .	83
TRANSPORTING THE MACHINE	83
MACHINE JACKING	85
STORAGE INFORMATION	86
FREEZE PROTECTION	86
SPECIFICATIONS	87
GENERAL MACHINE	
DIMENSIONS/CAPACITIES	87
GENERAL MACHINE PERFORMANCE ..	87
POWER TYPE	88
TIRES	88
FaST™ SYSTEM (OPTION)	88
MACHINE DIMENSIONS	89
INDEX	90

SAFETY PRECAUTIONS

The following symbols are used throughout this manual as indicated in their description:



WARNING: To warn of hazards or unsafe practices that could result in severe personal injury or death.

FOR SAFETY: To identify actions that must be followed for safe operation of equipment.

This machine is designed solely for scrubbing dirt and dust in an indoor environment. Tennant does not recommend using this machine in any other environment.

The following information signals potentially dangerous conditions to the operator or equipment. Read this manual carefully. Know when these conditions can exist. Locate all safety devices on the machine. Then, take necessary steps to train machine operating personnel. Report machine damage or faulty operation immediately. Do not use the machine if it is not in proper operating condition.



WARNING: Batteries emit hydrogen gas. Explosion or fire can result. Keep sparks and open flame away. Keep covers open when charging.



WARNING: Flammable materials can cause an explosion or fire. Do not use flammable materials in tank(s).



WARNING: Flammable materials or reactive metals can cause explosion or fire. Do not pick up.

FOR SAFETY:

1. **Do not operate machine:**
 - Unless trained and authorized.
 - Unless operation manual is read and understood.
 - In flammable or explosive areas unless designed for use in those areas.
2. **Before starting machine:**
 - Make sure all safety devices are in place and operate properly.
 - Check brakes and steering for proper operation (if so equipped).

3. **When using machine:**
 - Go slow on inclines and slippery surfaces.
 - Use care when backing machine.
 - Follow mixing and handling instructions on chemical containers.
4. **Before leaving or servicing machine:**
 - Stop on level surface.
 - Set parking brake.
 - Turn off machine and remove key.
5. **When servicing machine:**
 - Avoid moving parts. Do not wear loose jackets, shirts, or sleeves when working on machine.
 - Block machine tires before jacking machine up.
 - Jack machine up at designated locations only. Block machine up with jack stands.
 - Use hoist or jack that will support the weight of the machine.
 - Wear eye and ear protection when using pressurized air or water.
 - Disconnect battery connections before working on machine.
 - Avoid contact with battery acid.
 - Use Tennant supplied or equivalent replacement parts.
6. **When loading/unloading machine onto/off truck or trailer:**
 - Turn off machine.
 - Use truck or trailer that will support the weight of the machine.
 - Use winch. Do not drive the machine onto/off the truck or trailer unless the load height is 380 mm (15 in) or less from the ground.
 - Set parking brake after machine is loaded.
 - Block machine tires.
 - Tie machine down to truck or trailer.

SAFETY PRECAUTIONS

The safety labels appear on the machine in the locations indicated. If these or any label becomes damaged or illegible, install a new label in its place.

BATTERY CHARGING LABEL - LOCATED ON AND UNDERNEATH THE SEAT SUPPORT.

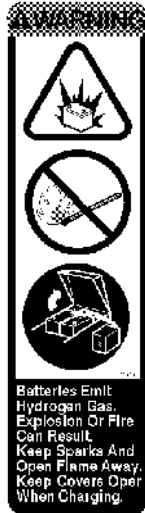

FLAMMABLE MATERIALS LABEL - LOCATED ON THE UNDERSIDE OF THE TANK COVER AND ON THE LEFT SIDE OF THE OPERATOR COMPARTMENT.



FLAMMABLE SPILLS LABEL - LOCATED ON THE SEAT SUPPORT.



FOR SAFETY LABEL - LOCATED ON THE SEAT SUPPORT.

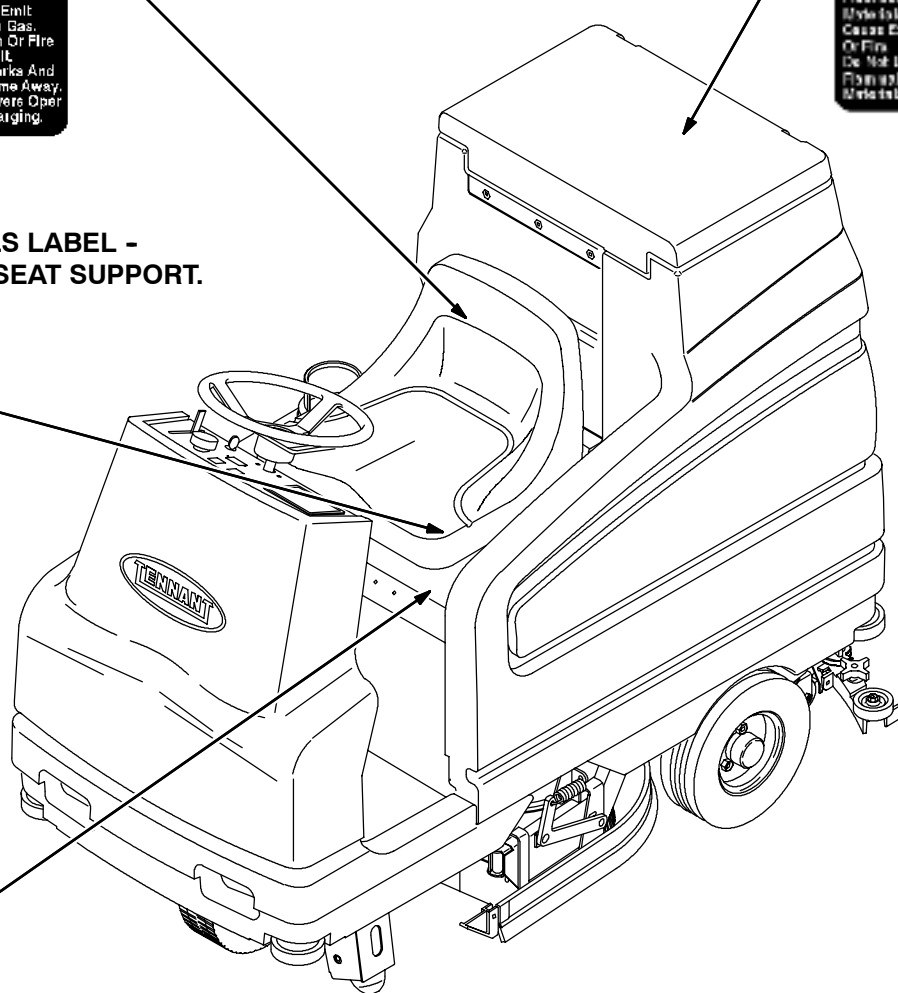

OPERATION

OPERATOR RESPONSIBILITY

- The operator's responsibility is to take care of the daily maintenance and checkups of the machine to keep it in good working condition. The operator must inform the service mechanic or supervisor when the maintenance intervals are required as stated in the *MAINTENANCE* section of this manual.
- Read this manual carefully before operating this machine.

FOR SAFETY: Do not operate machine, unless operation manual is read and understood.

- Check the machine for shipping damage. Check to make sure machine is complete per shipping instructions.
- Keep your machine regularly maintained by following the maintenance information in this manual. We recommend taking advantage of a regularly scheduled service contract from your TENNANT representative.
- Order parts and supplies directly from your authorized TENNANT representative. Use the parts manual provided when ordering parts.

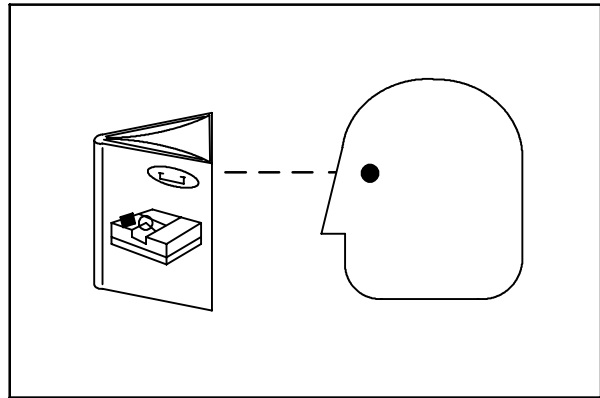

07324

MACHINE COMPONENTS

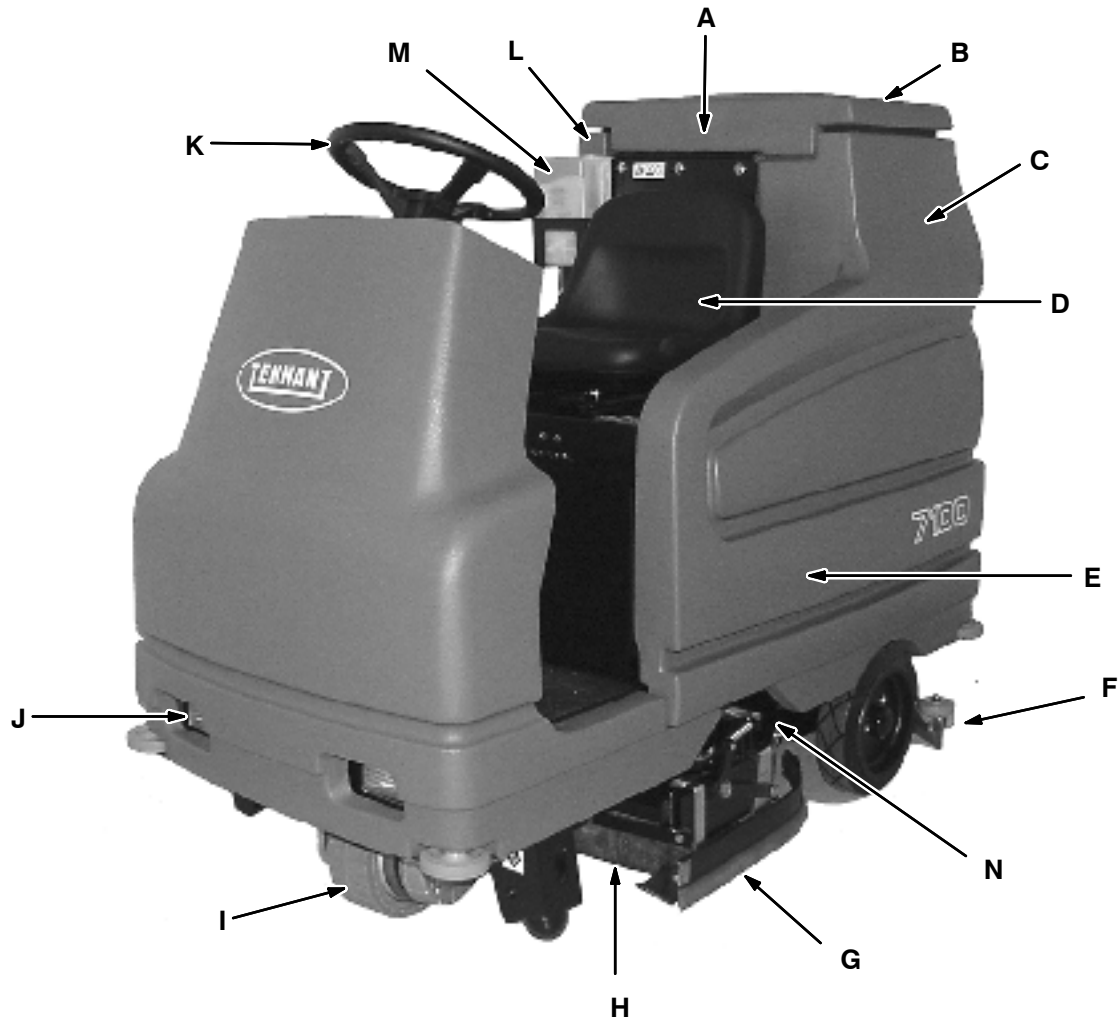

- A. Vacuum fan inlet screen
- B. Tank Cover
- C. Solution tank
- D. Operator's seat
- E. Batteries
- F. Rear squeegee
- G. Side squeegee
- H. Scrub head
- I. Front wheel
- J. Operating lights
- K. Steering wheel
- L. Recovery tank
- M. FaST™ PAK (option)
- N. FaST™ solution system (option)

CONTROL PANEL SYMBOLS

These symbols identify controls and displays on the machine:



Key switch

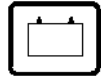

Battery charge



Scrub



Squeegee



Brush pressure



ES™ (Option)



FaST™ (Option)



Solution tank low



Recovery tank full



Solution flow



Operating lights switch



Circuit breaker #1



Circuit breaker #2



Circuit breaker #3



Circuit breaker #4



Circuit breaker #5



Circuit breaker #6



Circuit breaker #7



Circuit breaker #8



Circuit breaker #9



Power wand switch (option)

OPERATION

CONTROLS AND INSTRUMENTS

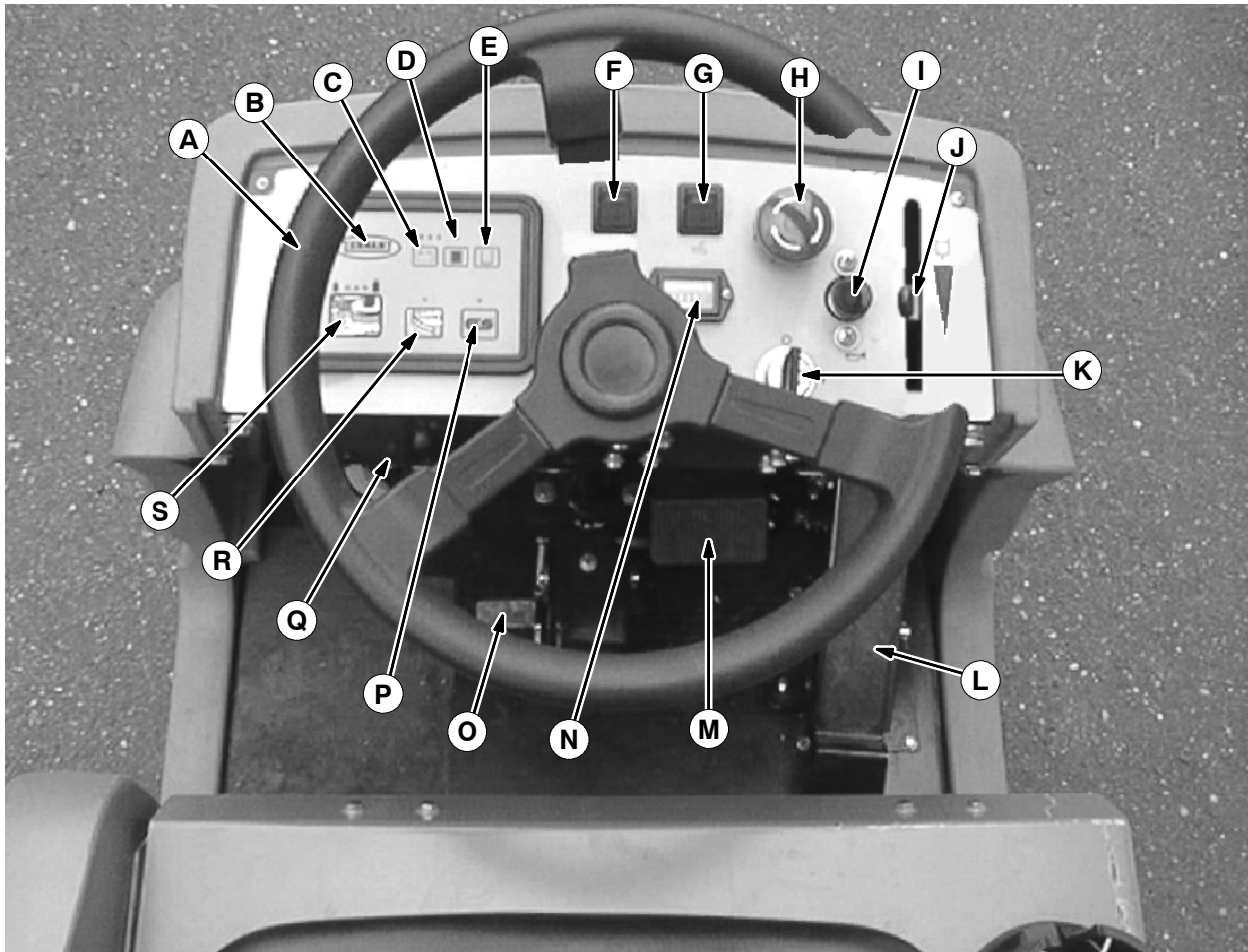

- A. Steering wheel
- B. Control panel
- C. Battery discharge indicator
- D. Recovery tank full indicator
- E. Solution tank empty indicator
- F. Operating lights switch
- G. Power wand switch (option)
- H. Power kill switch
- I. Horn button
- J. Solution flow lever
- K. On/Off key switch
- L. Directional pedal
- M. Brake pedal
- N. Hourmeter
- O. Parking brake pedal
- P. ES™ switch (option)
or FaST™ switch (option)
- Q. Circuit breaker panel
- R. Rear squeegee switch
- S. Scrub switch

OPERATION OF CONTROLS

BRAKE PEDAL

The *brake pedal* stops the machine.

Stop: Take your foot off the directional pedal and allow it return to the Neutral position. Step on the *brake pedal*.

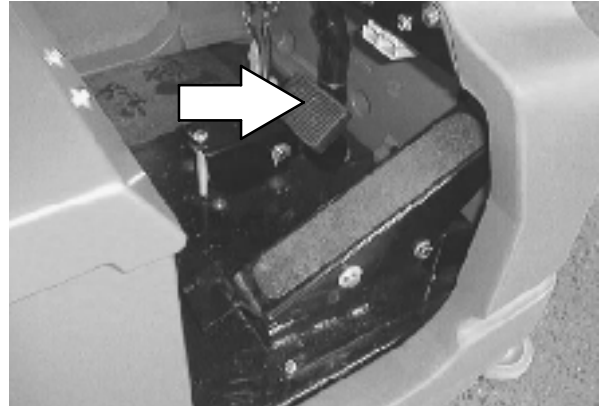
**PARKING BRAKE PEDAL**

The *parking brake pedal* sets the front wheel brake.

Set: Press the brake pedal down as far as possible, then press on the *parking brake pedal* with the toe of your foot to lock the *parking brake pedal* in place.

FOR SAFETY: Before leaving or servicing machine, stop on level surface, set parking brake, turn off machine, and remove key.

Release: Press down on the brake pedal until the parking brake releases.

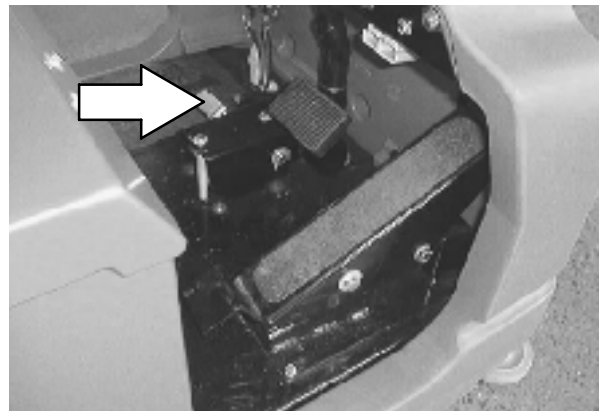
**DIRECTIONAL PEDAL**

The *directional pedal* controls direction of travel and the propelling speed of the machine. You change the speed of the machine with the pressure of your foot; the harder you press the faster the machine travels.

When the machine is moving forward and the *directional pedal* is reversed, the machine will coast for a short distance before changing direction. Use the brake pedal to stop the machine.

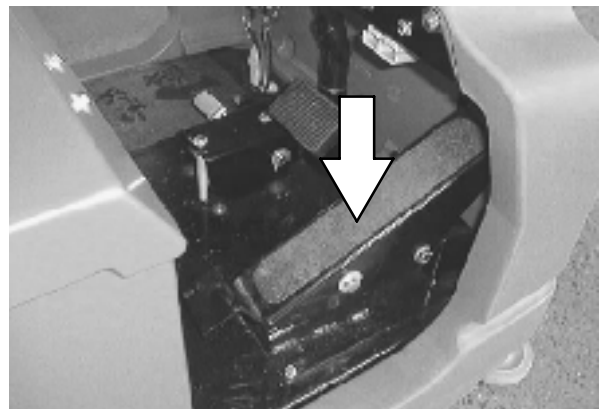

OPERATION

Forward: Press the top of the *directional pedal* with the upper part of your foot.

NOTE: The machine will not travel unless the operator is sitting in the operator's seat.

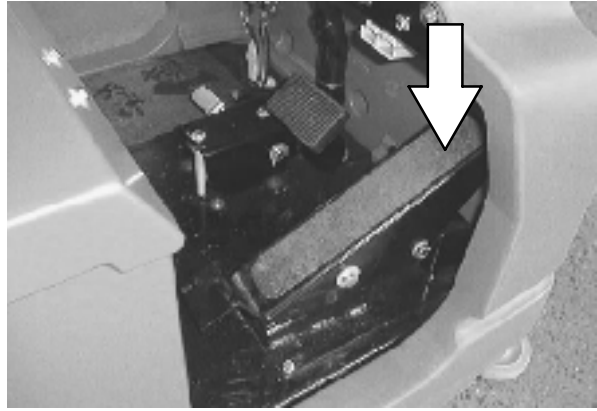

Reverse: Press the bottom of the *directional pedal* with the heel of your foot.

When the *directional pedal* is placed into the reverse position, the rear squeegee will automatically raise. After a short delay, the vacuum will stop.

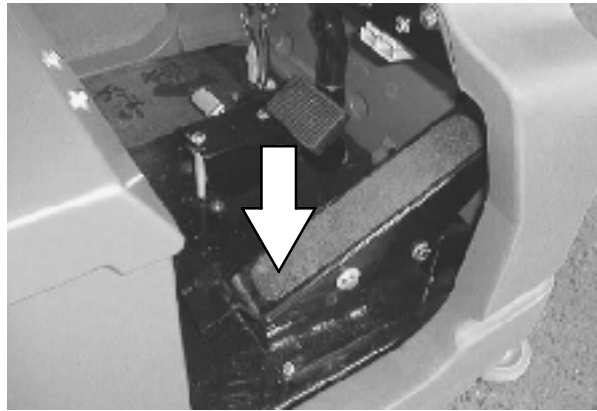

Neutral: Take your foot off the *directional pedal* and it will return to the neutral position.

When the *directional pedal* returns to the neutral position, the scrub brushes will stop and after a short delay, the scrub head will raise.



STEERING WHEEL

The *steering wheel* controls the machine's direction of travel.

Left: Turn the *steering wheel* to the left.

Right: Turn the *steering wheel* to the right.

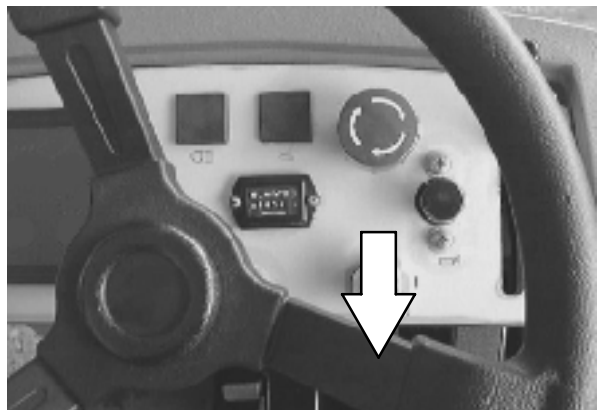

ON-OFF KEY SWITCH

The *on-off key switch* controls machine power with a key.

FOR SAFETY: When starting machine, keep foot on brake and directional pedal in neutral.

On: Turn the key all the way clockwise and release it to the on position.

Off: Turn the key all the way counterclockwise until it clicks into the off position.

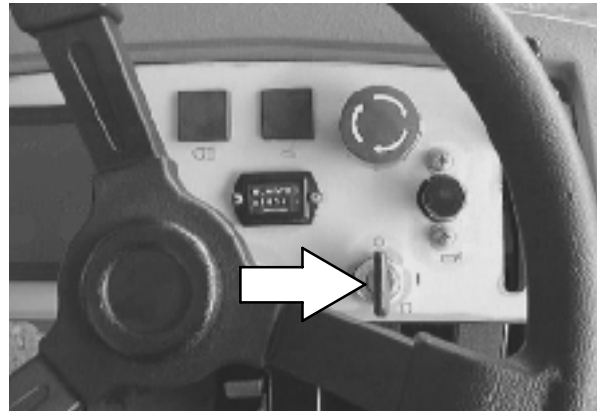

POWER KILL SWITCH

The *power kill switch* halts all power to the machine.

Stop machine power: Press the *power kill switch*.

Restart: Turn off the machine with the on/off switch. Turn the *power kill switch* to the right to release the switch. Turn on the machine with the on/off key switch.

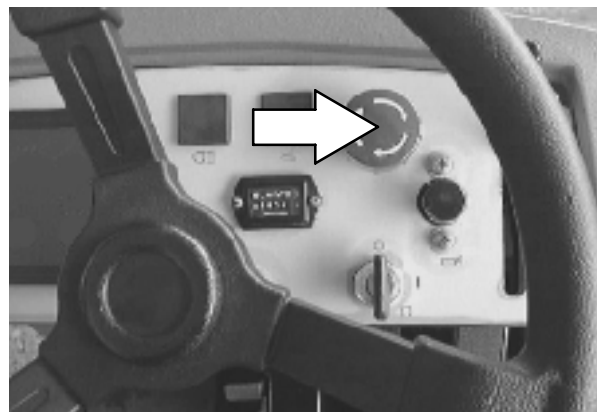

HOURMETER

The *hourmeter* records the number of hours the machine has been operated. Check the *hourmeter* regularly; this information is used to determine when to perform routine machine maintenance.

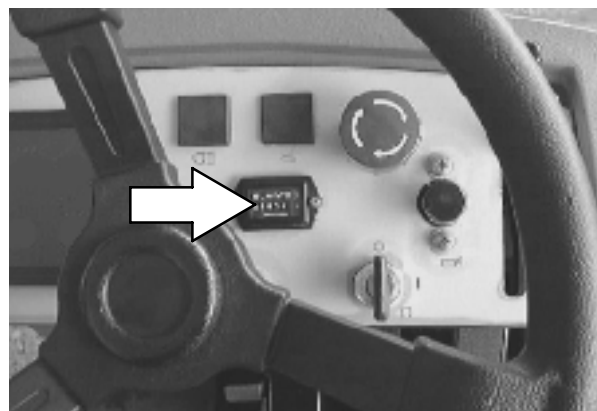

OPERATION

OPERATING LIGHTS SWITCH

The *operating lights switch* powers the headlights and the hazard lights (option) on and off.

On: Press the top of the *operating lights switch*.

Off: Press the bottom of the *operating lights switch*.

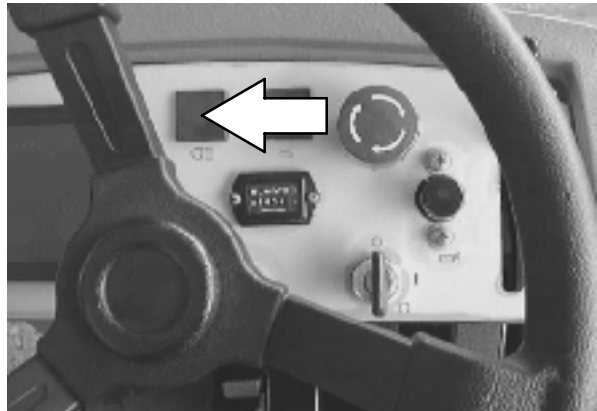

POWER WAND SWITCH (OPTION)

The *power wand switch (option)* powers the power wand on and off.

On: Press the top of the *power wand switch*.

Off: Press the bottom of the *power wand switch*.



HORN BUTTON

The *horn button* operates the horn.

Sound: Press the *horn button*.

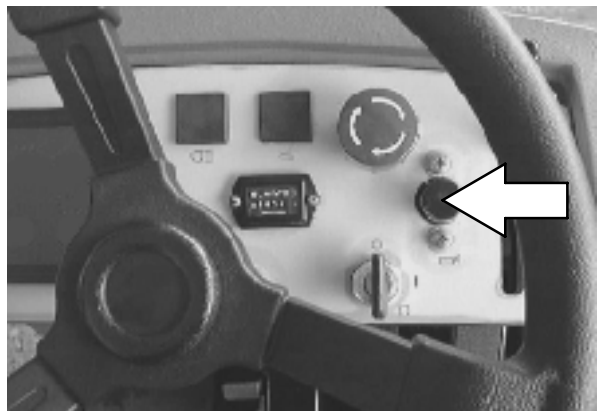

SCRUB SWITCH

The *scrub switch* controls the scrub head, scrub brushes, squeegee, and vacuum fan. The *scrub switch* is also used to set the scrub brush pressure.

Start scrubbing: Press the *scrub switch*. The indicator light will illuminate, the squeegee will lower, and the vacuum fan will start. The scrubbing system and solution flow will start when the directional pedal is pressed and the machine begins to move forward.

Stop scrubbing: Press the *scrub switch*. The pressure indicator light will go out. The scrub brushes will stop, the scrub head will raise, and the solution flow will stop. After a short delay, the rear squeegee will automatically raise. After another delay, the vacuum will stop.

The brush down pressure indicators display the pressure selection. The brush pressure indicator has three positions. Brush pressure increases as the indicator light moves to the right across the display. Travel speed and floor conditions will affect the scrubbing performance. Under normal conditions, the brush pressure should be set in one of the minimum settings. Set the brush pressure in one of the maximum settings to scrub a heavily soiled floor.

Change brush pressure: Press and hold the *scrub switch*. The pressure indicator light will cycle through the three brush pressure settings. When the switch is pressed and held, the brush pressure will increase until it reaches the maximum setting. The pressure will then return to the minimum setting. Release the *scrub switch* when the desired setting is indicated on the display.

NOTE: When the machine power is turned off, the brush pressure will remain in the last setting used.

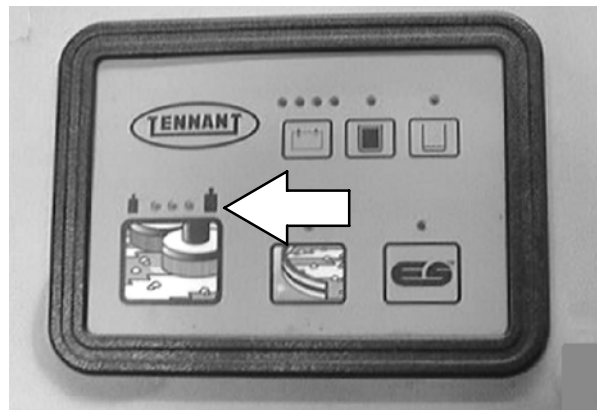
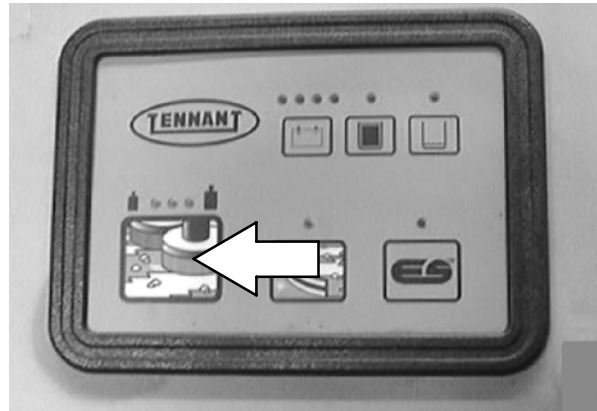

OPERATION

REAR SQUEEGEE SWITCH

The *rear squeegee switch* controls the vacuum fan and the position of the rear squeegee. The rear squeegee can be operated separately from the scrub brushes for the purpose of picking-up excess water without scrubbing, or double scrubbing without water pick up

Lower squeegee and start the vacuum fan: Press the *rear squeegee switch*. The indicator light above the switch will illuminate.

Raise squeegee and stop the vacuum fan: Press the squeegee switch. The indicator light above the switch will go off. There will be a slight delay before the vacuum shuts off.

NOTE: The rear squeegee lowers and the scrubbing vacuum starts automatically, when the scrubbing operations start.

NOTE: The rear squeegee will raise and the scrubbing vacuum will shut off after a short delay when the machine travels in reverse.

NOTE: The rear squeegee will raise and the scrubbing vacuum fan will shut off after a short delay when the scrubbing operations are shut off.

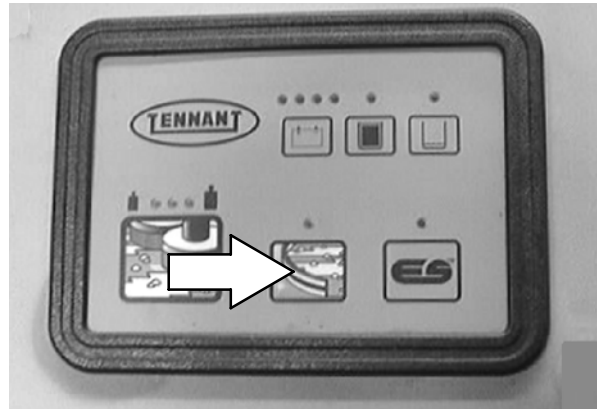

ES™ SWITCH (OPTION)

The *ES™ (Extended Scrub) switch* turns on and off the solution recycling system. When the scrubbing functions have started, the ES™ will default to the last setting used.

On: Press the *ES™ switch*. The indicator light above the switch will illuminate.

Off: Press the *ES™ switch*. The indicator light above the switch will turn off.

NOTE: The solution tank empty indicator light will not illuminate with machines equipped with the ES™ option.

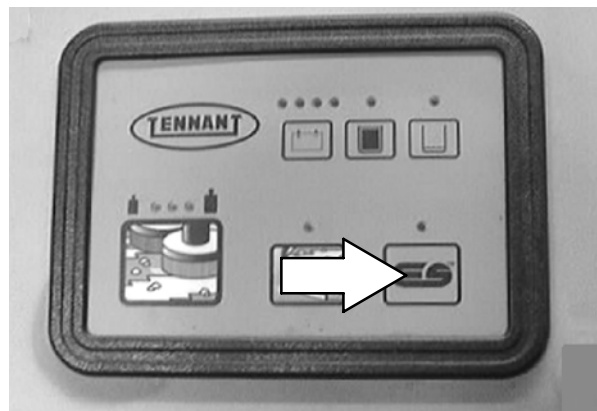

FaST™ SWITCH (OPTION)

The FaST™ switch (option) enables the FaST™ (Foam Scrubbing Technology) system. When the FaST™ system is enabled, it is turned on and off with the scrub switch.

On: Press the *FaST™ switch*. The indicator light above the switch will illuminate.

Off: Press the *FaST™ switch*. The indicator light above the switch will turn off.

NOTE: The FaST system will not start until the directional pedal is pressed.

NOTE: To use the machine for conventional scrubbing, disable the FaST™ system by turning the FaST™ switch off.

NOTE: Do not enable the FaST™ system with conventional cleaning detergents in the solution tank. Drain, raise and refill the solution tank with clear cool water only before operating the FaST™ system. Conventional cleaning detergents/restorers may cause failure to the FaST™ solution system.

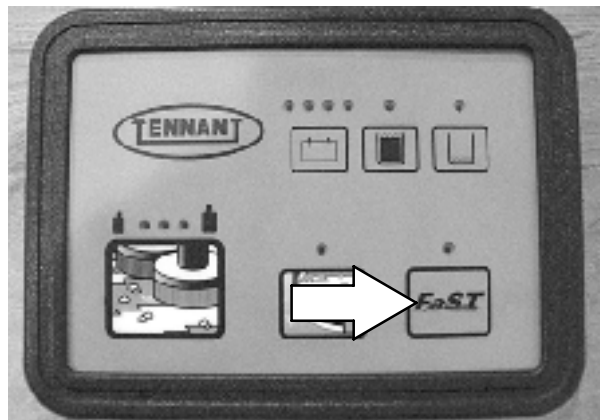
**SOLUTION TANK EMPTY INDICATOR**

The *solution tank empty indicator* will illuminate when the solution tank is empty.

NOTE: Machines with the ES™ option do not have this feature.

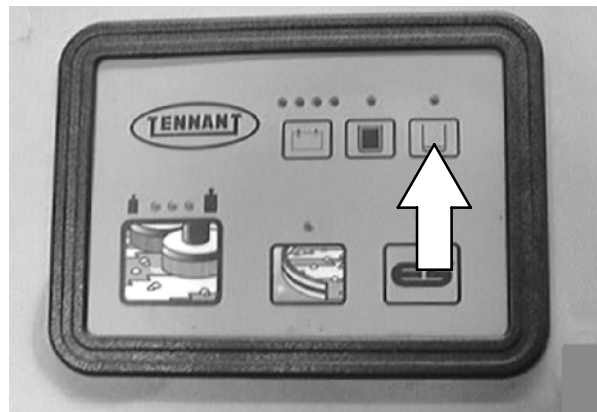
**RECOVERY TANK FULL INDICATOR**

The *recovery tank full indicator* will illuminate when the recovery tank is full.

NOTE: When the indicator illuminates, all scrubbing functions will shut off automatically.

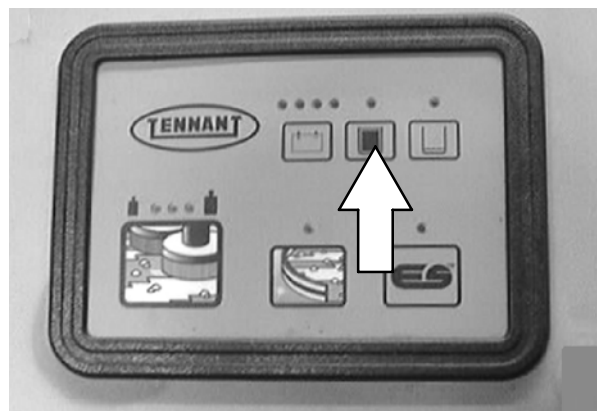

OPERATION

BATTERY DISCHARGE INDICATOR

The *battery discharge indicator* displays the charge level of the batteries while the machine is operating.

When the batteries are fully charged, all four indicator lights are lit. As the batteries discharge, the indicator lights will go out from right to left. The batteries should be recharged when the indicator on the left flashes. *When the indicator flashes, all scrubbing functions will shut off automatically.* Drive the machine to the battery charging area and charge the batteries immediately after the *battery discharge indicator* begins to flash.

NOTE: The battery discharge indicator will not stop flashing until the batteries have been fully charged.

NOTE: Do not charge the batteries more often than is necessary to prolong the life of the batteries. Do not charge the batteries with a "top off" charge if there is enough remaining charge in the batteries for the next machine use. Discharge the batteries to a 20% level, when the battery discharge indicator segments shut off, before fully charging the batteries. Do not allow the batteries to become completely discharged as this will also damage the batteries. See BATTERIES in the MAINTENANCE section.

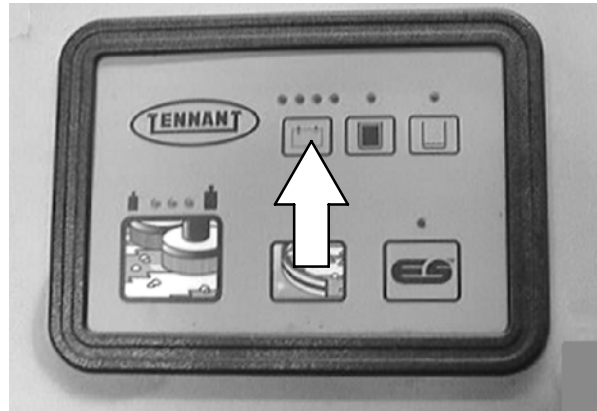

CIRCUIT BREAKERS

Circuit breakers are resettable electrical circuit protection devices designed to stop the flow of current in the event of a circuit overload. Once a *circuit breaker* is tripped, reset it manually by pressing the reset button after the breaker has cooled down.

If the overload that caused the *circuit breaker* to trip is still present, the *circuit breaker* will continue to stop current flow until the problem is corrected.

The *circuit breakers* are located on the operator console.

The chart below shows the *circuit breakers* and the electrical components they protect.

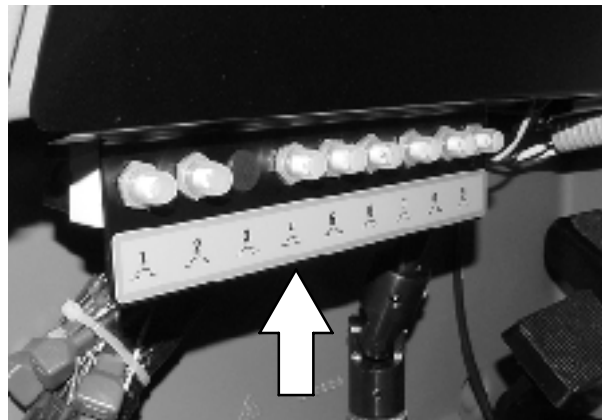

Circuit Breaker	Rating	Circuit Protected
CB1	5 A	Machine power
CB2	10 A	Lights
CB3	10 A	Horn
CB4	10 A	Power wand/ Back up alarm
CB5	10 A	Control panel
CB6	20 A	Vacuum Fan (single)
CB6	40 A	Vacuum Fan (dual)
CB7	10 A	ES™ System (option) FaST™ System (option)
CB8	25 A	Left brush motor
CB9	25 A	Right brush motor

FUSE

The *fuse* is a one-time protection device designed to stop the flow of current in the event of a circuit overload.

NOTE: Always replace the fuse with a fuse of the same amperage.

The *fuse* is located behind the operator console. Access the *fuse* by lowering the operator console.

Fuse	Rating	Circuit Protected
FU-1	40 A	Propelling

OPERATION

SOLUTION FLOW LEVER

The *solution flow lever* controls the amount of solution that flows to the floor while scrubbing.

Increase solution flow: Push the lever forward.

Decrease solution flow: Pull the lever backward.

NOTE: The machine is equipped with a solenoid valve that automatically stops the solution flow when the directional pedal is in the neutral position or when the scrub head is raised.

NOTE: When using the FaST system (option), the solution flow lever is nonfunctional. The FaST™ system flow rate is pre-set.

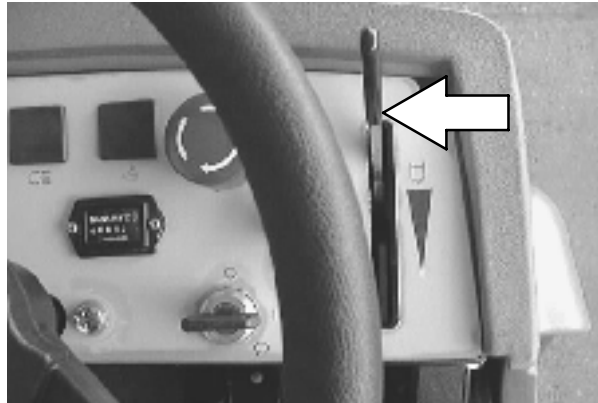

OPERATOR SEAT

The *operator seat* is a fixed back style with a forward-backward adjustment.

Adjust: Pull the lever outward and slide the seat to the desired position, then release the lever.

NOTE: The machine will not travel unless the operator is sitting in the operator's seat.



SEAT SUPPORT ARM

The *seat support arm* holds the seat up to allow access to the batteries. The *seat support arm* automatically engages when the seat is lifted all the way up. Lower the seat support by slightly raising it while pushing the support arm inward.

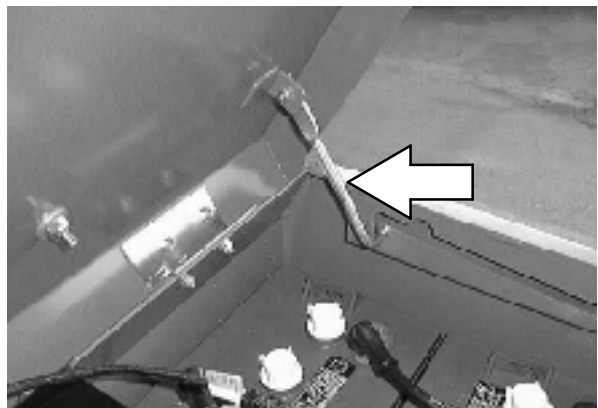

SQUEEGEE WHEEL CAMS

The *squeegee wheel cams* adjust the rear squeegee deflection along the entire length of the rear squeegee. There are wheel cams at either end of the squeegee.

Increase deflection: Turn the cams counterclockwise.

Decrease deflection: Turn the cams clockwise.

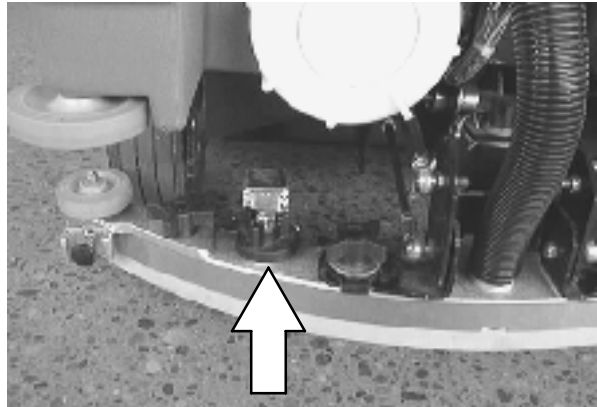

SQUEEGEE LEVELING KNOB

The *squeegee leveling knob* adjusts the deflection at the ends of the rear squeegee.

The *squeegee leveling knob* is located directly behind the squeegee suction hose. **DO NOT** disconnect the suction hose from the squeegee frame when leveling the squeegee.

Increase end deflection: Turn the *squeegee leveling knob* counterclockwise to increase the deflection at the end of the squeegees.

Decrease end deflection: Turn the *squeegee leveling knob* clockwise to decrease the deflection at the end of the squeegees.

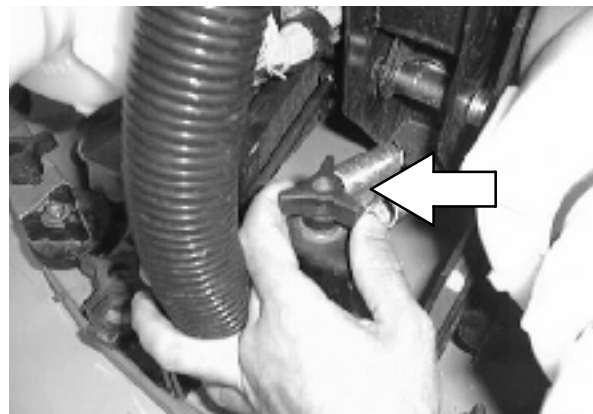

HOW THE MACHINE WORKS

The following machine components work together to effectively clean dirty floors: solution tank, scrub brushes, squeegee, vacuum fan, and recovery tank.

Water and detergent from the solution tank flow to the floor through a solution valve. The brushes use the detergent and water solution to scrub the floor clean. As the machine propels forward, the squeegee wipes the dirty solution from the floor. The suction created by the vacuum fan then draws the dirty solution from the squeegee into the recovery tank.

The *steering wheel* controls the direction of machine travel. The *directional pedal* controls the speed and direction of the machine. The *brake pedal* slows and stops the machine.

When using the ES™ mode (option), the dirty solution in the recovery tank is filtered and returned to the solution tank to be reused for extended scrubbing.

The four available scrub head types use *disk* or *cylindrical* brushes.

Two different widths of scrub heads are available for each type. Both the cylindrical and disk scrub heads are available in 700 mm (28 in) and 800 mm (32 in) widths.

NOTE: The amount and type of soilage play an important role in determining the type of brushes to be used. For specific recommendations, contact your Tennant representative.

When finished scrubbing, clean the recovery tank. If using the ES™ system, drain and clean the solution tank, and clean the ES™ filter.



FaST™ SCRUBBING SYSTEM (OPTION)

Unlike conventional scrubbing, the FaST™ (Foam Scrubbing Technology) system operates by injecting the FaST™ PAK concentrate agent into the system with a small amount of water and compressed air. This mixture creates a large volume of expanded wet foam.

The expanded foam mixture is then dispersed onto the floor while the machine is scrubbing. When the squeegee picks up the mixture, the patented foaming agent has collapsed and is recovered into the recovery tank.

The FaST™ system can be used with all double scrubbing and heavy duty scrubbing applications.

Using the FaST™ system can increase productivity by 30% by reducing your dump/fill cycle. It will also reduce chemical usage and storage space. One FaST™ PAK of concentrated agent can scrub up to 1 million sq. ft.

NOTE: Do not enable the FaST™ system with conventional cleaning detergents in the solution tank. Drain, raise and refill the solution tank with clear cool water only before operating the FaST™ system. Conventional cleaning detergents/restorers may cause failure to the FaST™ solution system.



FaST
Foam Scrubbing Technology®

The safe scrubbing alternative®

PRE-OPERATION CHECKLIST

Check over this list of items before operating the machine:

- Check under the machine for leaks.
- Check the brakes and steering for proper operation.
- Check for wire, string, or twine wrapped around the scrub brushes.
- Check the squeegees for wear or damage.
- Check the squeegee suction hose for obstructions.
- Cylindrical brushes: Check that the debris tray is empty and clean.
- ES™ machines. Check that the ES™ filter is clean.
- Check the recovery tank cover seals for wear or damage.
- Check that the vacuum fan inlet filter is clean.
- FaST™ Scrubbing: Check the FaST PAK (option) concentrate agent level, replace carton as needed. See the INSTALLING THE FaST™ PAK AGENT section of the manual.
- FaST™ Scrubbing: Check that all conventional cleaning agents/restorers are drained and rinsed from the solution tank.
- FaST™ Scrubbing: Check that solution tank is filled with **clear cool water only**.

INSTALLING FaST™ PAK AGENT (OPTION)

NOTE: Machine must be equipped with the FaST option.

1. Remove the perforated knock-outs from the FaST™ PAK Floor Cleaning Concentrate carton. Do not remove the bag from the carton. Pull out the bag's hose connector on the bottom of the bag and remove the hose cap from the connector.

NOTE: The FaST™ PAK Floor Cleaning Concentrate is specially designed for use with the FaST™ system scrubbing application. NEVER use a substitute, machine damage will result.

FOR SAFETY: When using machine, always follow the handling instructions on chemical container.

2. Empty the solution tank. See DRAINING AND CLEANING THE TANKS section of the manual.

NOTE: When scrubbing with the FaST™ system option, use clean water only. Do not add cleaning agents/restorers in the solution tank. Conventional cleaning agents/restorers may cause failure to the FaST solution system..

3. Place the FaST™ PAK carton in the carton holder located next to the seat. Connect the supply hose to the FaST™ PAK bag.

NOTE: If any dried concentrate is visible on the supply hose connector or the on the FaST™ PAK connector, soak and clean with warm water.

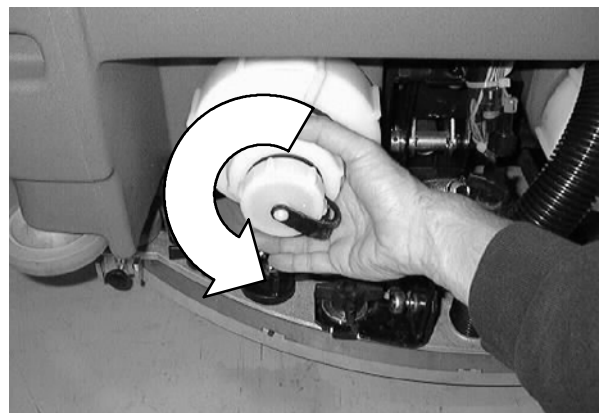
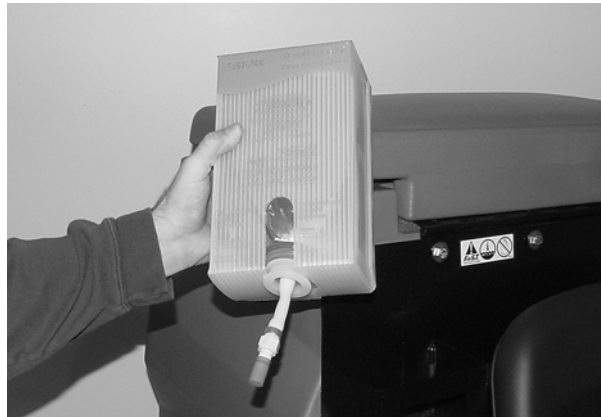

OPERATION

4. Make sure to connect the supply hose onto the hose storing plug when the supply hose is not connected to the FaST™ PAK. This will prevent the FaST™ solution system from drying out and clogging up the hose.
5. FIRST TIME USE: The FaST™ solution system is protected against freezing during shipment. You must operate the FaST™ system for 10 minutes to disperse the mixture of RV anti-freeze/FaST detergent before you achieve maximum foaming.
6. When replacing an empty FaST™ PAK carton, allow the new FaST™ PAK detergent to gravity feed into the system for several minutes prior to operating the FaST™ system. If the detergent does not flow out of the FaST™ PAK, simply squeeze and release the hose several times. If the previous FaST™ PAK was run dry, it may take up to 5-10 minutes of operation to remove any air pockets in the system before you achieve maximum foaming.

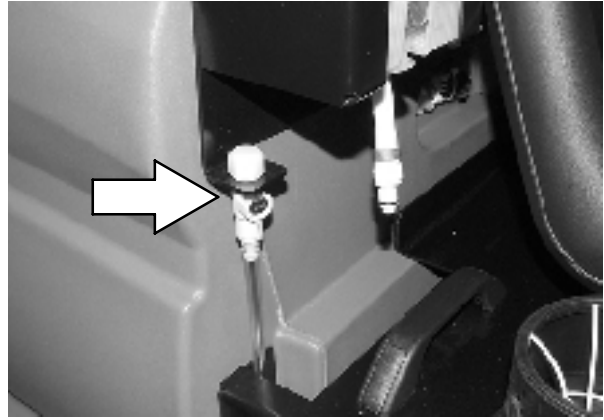

STARTING THE MACHINE

1. You must be in the operator's seat with the directional pedal in neutral, and your foot on the *brake pedal* or with the parking brake set.

FOR SAFETY: When starting machine, keep foot on brake and directional pedal in neutral.

2. Turn the machine power on.
3. Release the machine parking brake.
4. Drive the machine to the area to be cleaned.

NOTE: The machine will not travel unless the operator is sitting in the operator's seat.

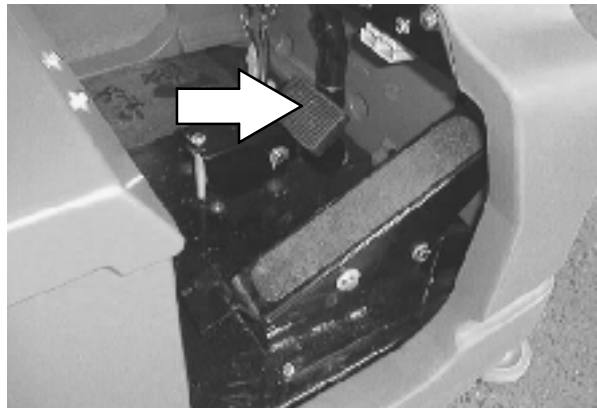

FILLING THE TANKS

1. Turn the machine power on. See the STARTING THE MACHINE section of the manual.

FOR SAFETY: When starting machine, keep foot on brake and directional pedal in neutral.

2. Drive the machine to the tank filling site.

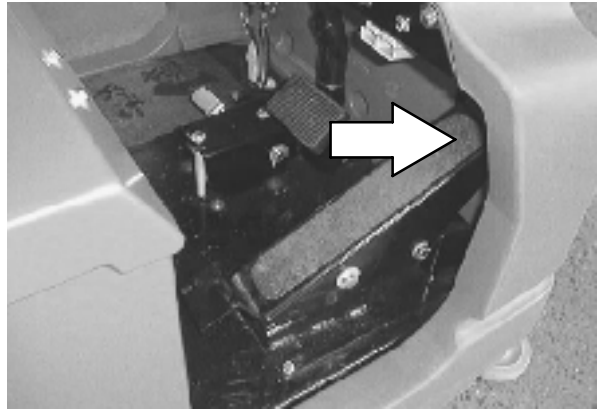

3. Turn the machine power off. See the STOP THE MACHINE section of the manual.

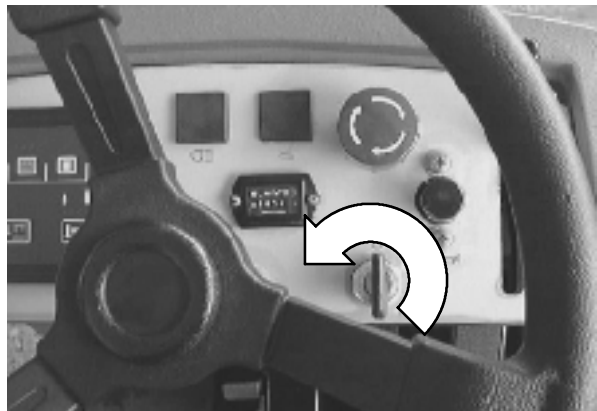

4. Set the machine parking brake.

FOR SAFETY: Before leaving or servicing machine, stop on level surface, set parking brake, turn off machine, and remove key.

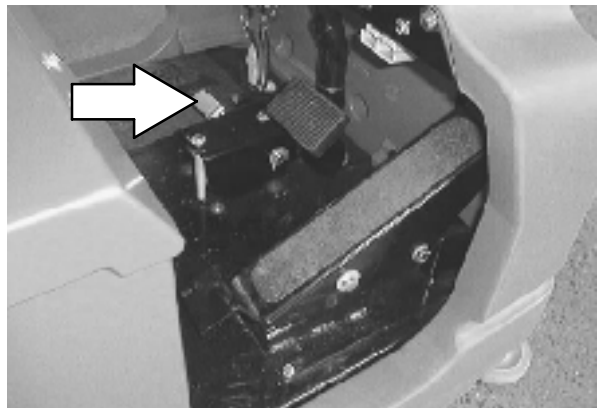

OPERATION

5. **CONVENTIONAL SCRUBBING:** Open the solution tank cover. Measure and pour in the correct amount of detergent. Fill the rest of the solution tank with water up to the FULL line near the top of the tank.

NOTE: Floor conditions, water condition, amount of soilage, type of soilage, and brush pressure all play an important role in determining the type and concentration of detergent used. For specific recommendations, contact your Tennant representative.



WARNING: Flammable materials can cause an explosion or fire. Do not use flammable materials in tank(s).

FOR SAFETY: When using machine, follow mixing and handling instructions on chemical containers.

6. **ES™ (option):** Fill the recovery tank with water and detergent up to the lower sensor float to extend scrub time. Make sure the ES™ system is on.



WARNING: Flammable materials can cause an explosion or fire. Do not use flammable materials in tank(s).

FOR SAFETY: When using machine, follow mixing and handling instructions on chemical containers.

*NOTE: If you **DO NOT** want to use the ES™ mode (option), **DO NOT** put water in the recovery tank and make sure the ES™ system is off.*

7. **FaST™ SCRUBBING (option):** Open the solution tank cover and fill the solution tank to the FULL line near the top of the tank with cool clear water only. Do not add cleaning detergents.

NOTE: When cleaning using FaST™ option, USE CLEAR COOL WATER ONLY. DO NOT add cleaning detergents in solution tank. Conventional cleaning detergents/restorers may cause failure to the FaST™ solution system.

8. Lower the tank cover.

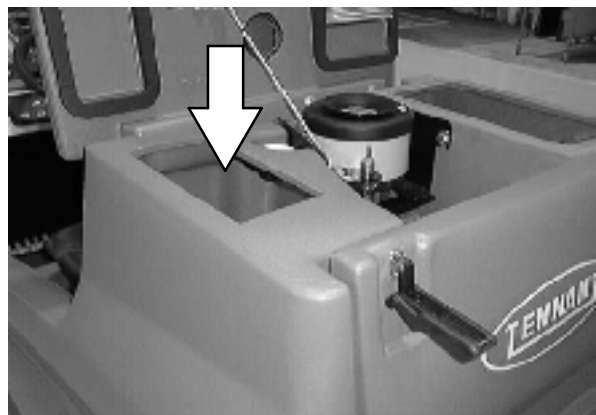
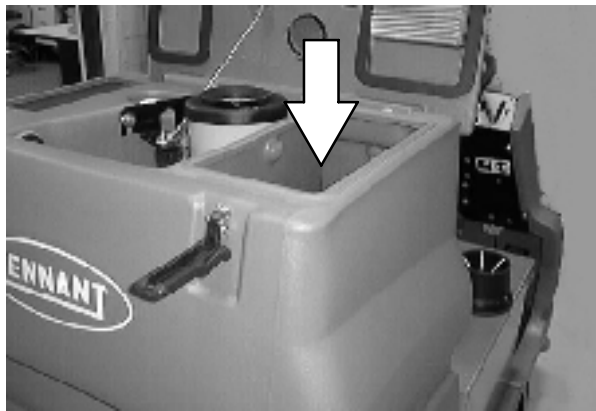
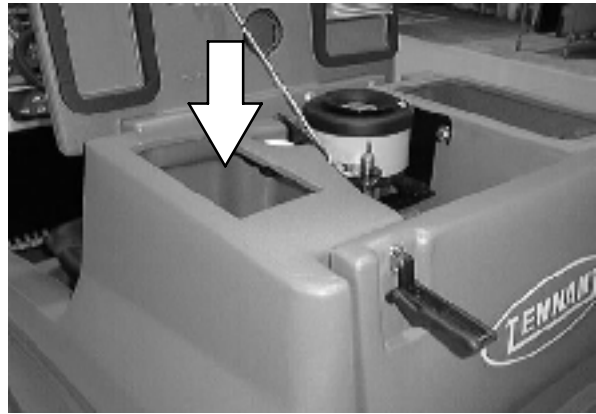

SCRUBBING AND BRUSH INFORMATION

Pick up oversized debris before scrubbing. Pick up pieces of wire, string, twine, etc., which could become wrapped around the scrub brush.

Plan the scrubbing in advance. Try to arrange long runs with minimum stopping and starting. Do an entire floor or section at one time.

Drive as straight a path as possible. Avoid bumping into posts or scraping the sides of the machine. Overlap the scrub paths by several centimeters (a few inches).

Avoid turning the steering wheel too sharply when the machine is in motion. The machine is very responsive to the movement of the steering wheel. Avoid sudden turns, except in emergencies.

When scrubbing dead end aisles, start at the closed end of the aisle and scrub your way out.

Adjust the machine speed, scrub brush pressure, and solution flow as required when scrubbing. Use minimum scrub brush pressure and solution flow required for the best results.

If you see poor scrubbing performance, stop scrubbing and refer to *MACHINE TROUBLESHOOTING*.

For best results, use the correct brush type for your cleaning application. The following are recommended brush applications.

Non-scuff polypropylene scrub brush - This brush uses a softer, general purpose polypropylene bristle to lift lightly compacted soilage without scuffing high-gloss coated floors.

Nylon scrub brush - Recommended for scrubbing coated floors. Cleans without scuffing.

Super abrasive bristle scrub brush - Nylon fiber impregnated with abrasive grit to remove stains and soilage. Strong action on any surface, performing well on buildup, grease, or tire marks.



07218

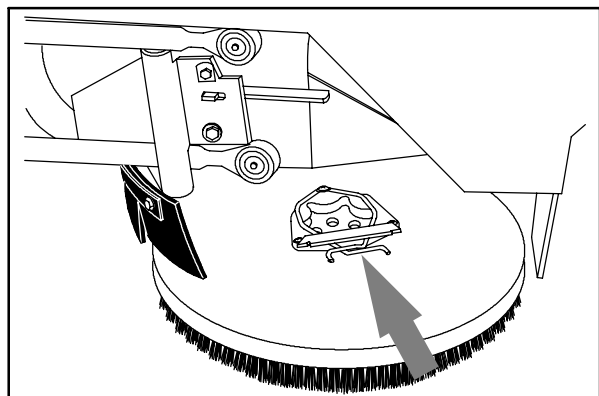

05939

OPERATION

Heavy duty stripping pad – This black pad is for stripping floors. Cuts through old heavy finishes easier, to prepare the floor for re-coating.

Stripping pad – This brown pad is for stripping floors. Quickly and easily cuts through old finish to prepare the floor for re-coating.

Scrubbing pad – This blue pad is for scrubbing floors. Removes dirt, spills and scuffs, leaving a clean surface ready for re-coating.

Buffing pad – This red pad is for buffing floors. Quickly cleans and removes scuff marks while polishing the floor to a high gloss.

Polishing pad – This white pad is for polishing floors. Maintains a high gloss. Use for buffing very soft finishes and lower traffic areas, or use for polishing soft waxes on wood floors.

Cylindrical polypropylene scrub brush – This cylindrical brush uses a softer, general purpose polypropylene bristle to lift lightly compacted soilage without scuffing high-gloss coated floors.

Cylindrical nylon scrub brush – This cylindrical brush is recommended for scrubbing coated floors. Cleans without scuffing.

Cylindrical super abrasive bristle scrub brush – Nylon fiber impregnated with abrasive grit to remove stains and soilage. Strong action on any surface, performing well on buildup, grease, or tire marks.

NOTE: Cylindrical scrub brushes must be installed with the herringbone patterns on the brushes pointing towards each other for best debris pick up.

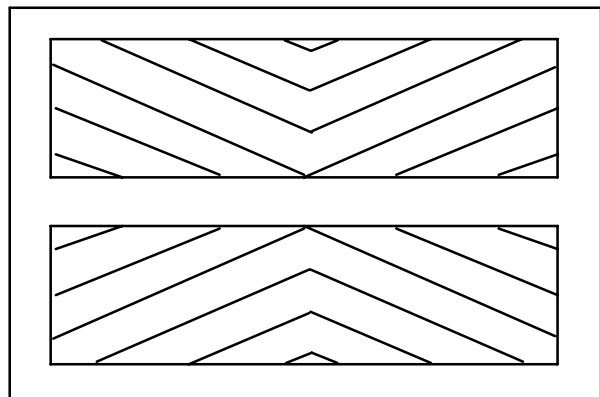

SCRUBBING

1. Start the machine. See the STARTING THE MACHINE section of the manual.

FOR SAFETY: When starting machine, keep foot on brake and directional pedal in neutral.

2. Drive the machine to the area to be cleaned.

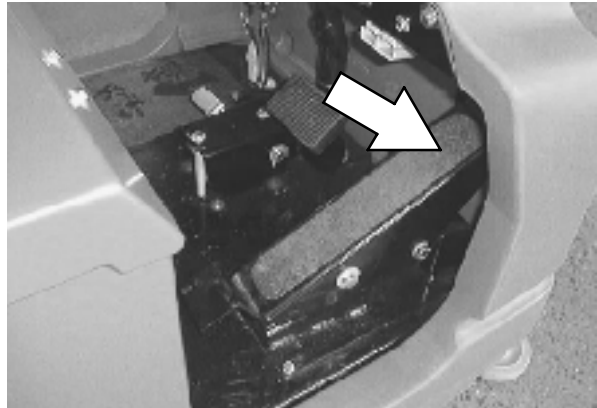

3. Press the *scrub switch* to start the scrubbing operations. See the SCRUB SWITCH section of the manual.

⚠ WARNING: Flammable materials or reactive metals can cause explosion or fire. Do not pick up.

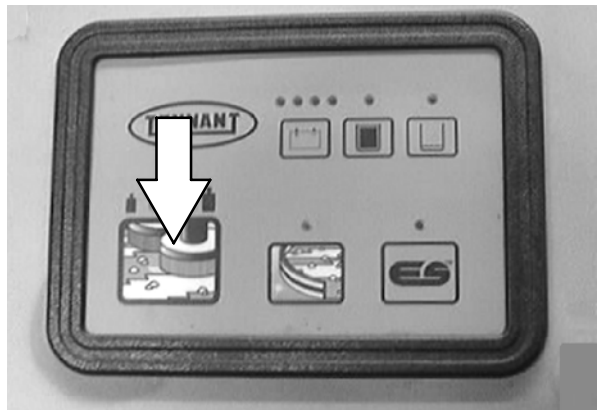

4. FaST™ SCRUBBING (option): Press the *FaST switch* to enable the FaST™ system. See the FaST SWITCH (option) section of the manual.

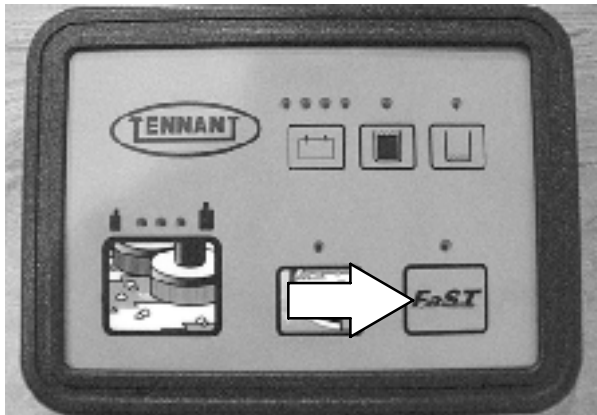

OPERATION

5. CONVENTIONAL SCRUBBING: Adjust the solution flow as needed.

NOTE: When using the FaST system (option), the solution flow lever is nonfunctional. The FaST™ system flow rate is pre-set.

Increase flow: Push the *solution flow lever* forward. Use this flow rate for rough floors and heavy or compacted dirt.

NOTE: For machines equipped with cylindrical scrub heads, decrease solution flow rate when turning.

Decrease flow: Pull the *solution flow lever* back. Use this flow rate for smooth floors and light dirt.

Stop flow: Pull the lever all the way back.

6. Press the directional pedal forward and scrub as required. When the machine moves forward the scrub head will lower and the scrub brushes will start. The rear squeegee will lower and the vacuum fan will start. The conventional scrubbing solution system will start when the machine first begins to move forward. The optional ES™ system and FaST™ system will start, if the switch is on.

NOTE: The scrub head will raise when the directional pedal is in the neutral position. The rear squeegee will raise when the directional pedal is in the reverse position.

NOTE: If an excess of water in the recovery tank triggers an overflow switch, the recovery tank full indicator will light on the control panel. All scrubbing functions will be canceled. To turn the indicator light off, drain the recovery tank, then press the scrub switch.

NOTE: A low battery and a no brush current sensed will also cancel the scrub system.

7. Adjust brush pressure for cleaning application. See the SCRUB SWITCH section of the manual.
8. Press the ES™ switch (option) if extended scrubbing is necessary.

NOTE: The recovery tank must be half full to use the ES™ option. A full solution tank will turn off the ES pump



WARNING: Flammable materials or reactive metals can cause explosion or fire. Do not pick up.

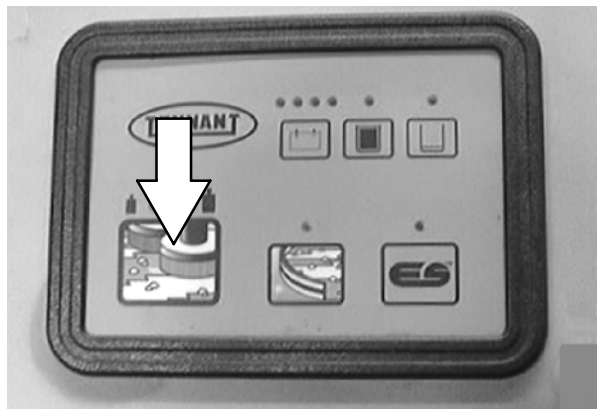
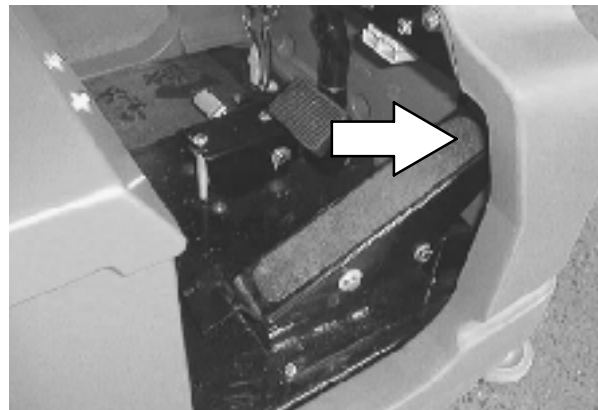
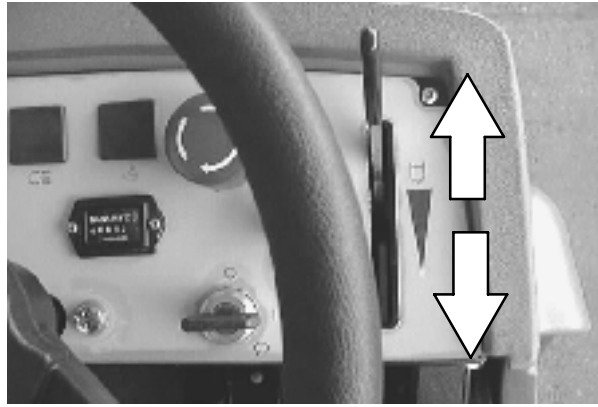

DOUBLE SCRUBBING

Double scrubbing is the process of making two or more scrubbing passes over a heavily soiled area. The first scrubbing pass is made with rear squeegee up to allow the solution to soak into the floor.

Double scrubbing can be performed using the FaST™ SCRUBBING SYSTEM (option) or CONVENTIONAL SCRUBBING methods.

Press the *scrub switch* to start the normal scrubbing operations.

Press the *rear squeegee switch* to raise the rear squeegee and turn off the vacuum system.

Use the maximum solution flow setting and a higher brush pressure setting. Let the solution remain on the floor for 5 to 15 minutes. Decrease the solution flow, then make a second scrubbing pass with the rear and side squeegees down.

NOTE: When using the FaST™ system (option), the solution flow lever is nonfunctional. The FaST™ system flow rate is pre-set.

FOR SAFETY: When using machine, go slow on inclines and slippery surfaces.

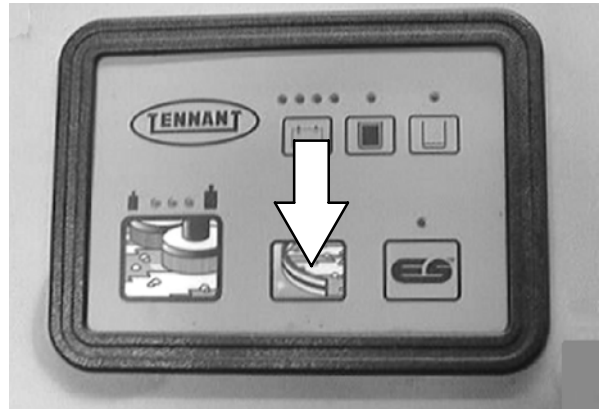

OPERATION ON INCLINES

Drive the machine slowly on inclines.

FOR SAFETY: When using machine, go slow on inclines and slippery surfaces.

The maximum rated climb and descent incline with empty tanks is 11°, with full tanks is 4°.

FOR SAFETY: Before leaving or servicing machine, stop on level surface.

OPERATION

STOP SCRUBBING

1. Press the *scrub switch* to stop the scrubbing operations.

The scrub brushes will stop and the scrub head will raise. The ES™ detergent pump (option) will stop, and the solution flow will stop, the FaST system (option) will stop. After a short delay, the rear squeegee will automatically raise and the scrubbing vacuum fan will stop.

Continue driving the machine forward until the rear squeegee raises, and the vacuum fan shuts off.

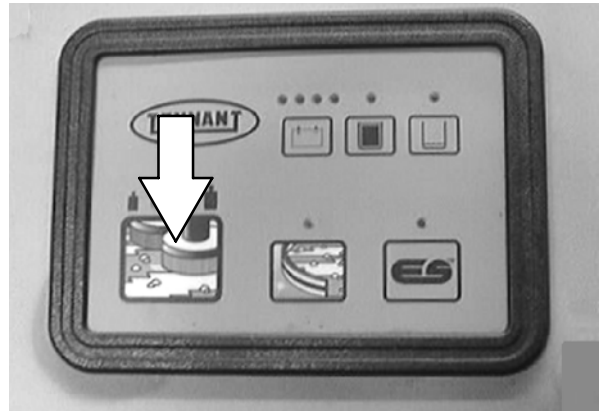

2. When the vacuum fan stops, take your foot off the *directional pedal*.



3. Press the *brake pedal* to stop the machine.

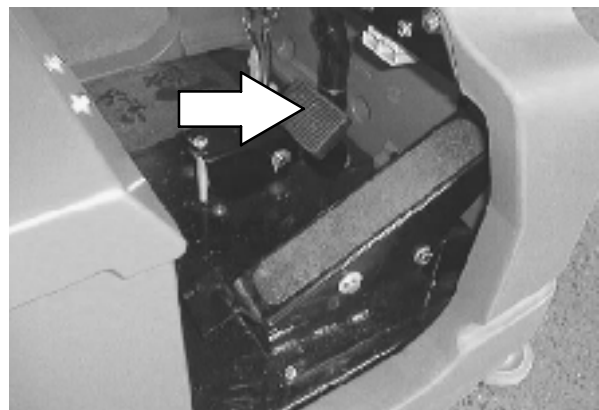

DRAINING AND CLEANING THE TANKS

When you are finished scrubbing, or when the *recovery tank full indicator* illuminates, the recovery tank should be drained and cleaned. The solution tank can then be filled again for additional scrubbing if necessary.

If you used the machine in ES™ mode (option), the solution tank should also be drained and cleaned when you finish scrubbing.

1. Stop scrubbing. See the STOP SCRUBBING section of the manual.
2. Drive the machine next to an appropriate disposal site.
3. Turn the machine power off. See the STOP THE MACHINE section of the manual.

FOR SAFETY: Before leaving or servicing machine, stop on level surface, and turn off machine.



4. Set the machine parking brake.

FOR SAFETY: Before leaving or servicing machine, stop on level surface, set parking brake, turn off machine, and remove key.

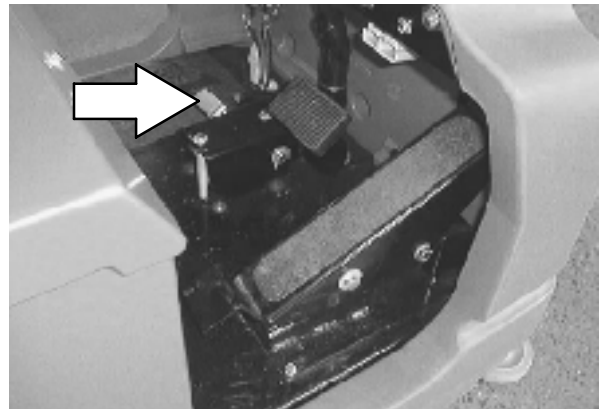

OPERATION

5. Access the recovery tank drain hose by loosening the retaining ring and then pulling the hose out.

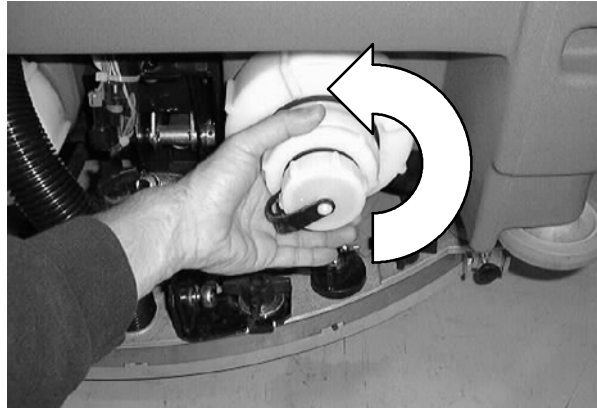

6. Remove the drain hose cap while holding the hose up, then slowly lower the drain hose to the floor drain.

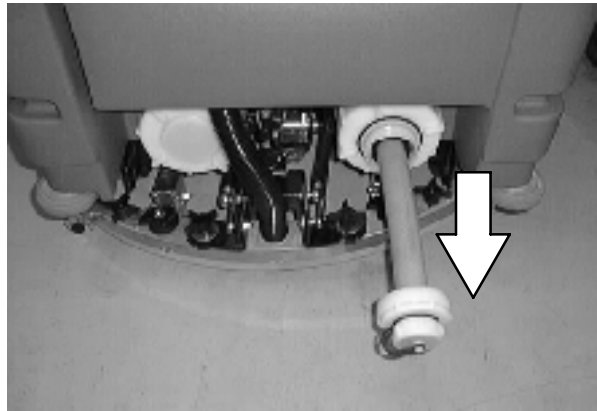

7. Flush out the inside of the recovery tank with clean water.
8. ES™ mode (option): Flush out the recovery tank with clean water. Rinse the ES™ filter at the bottom, and the pressure switches near the top of the tank.

NOTE: DO NOT use steam to clean the tanks. Excessive heat can damage the tanks and components.

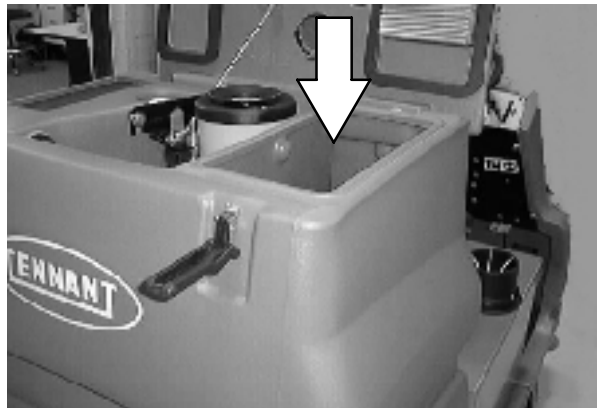

9. ES™ mode (option): Access the solution tank drain hose by loosening the retaining ring and then pulling the hose out.

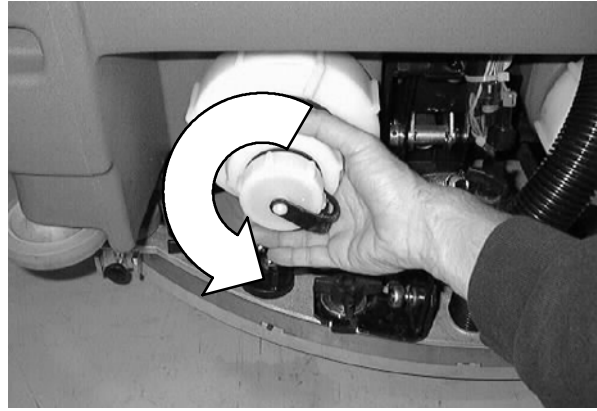

10. ES™ mode (option): Remove the solution tank drain hose cap while holding the hose up, then slowly lower the drain hose to the floor drain.

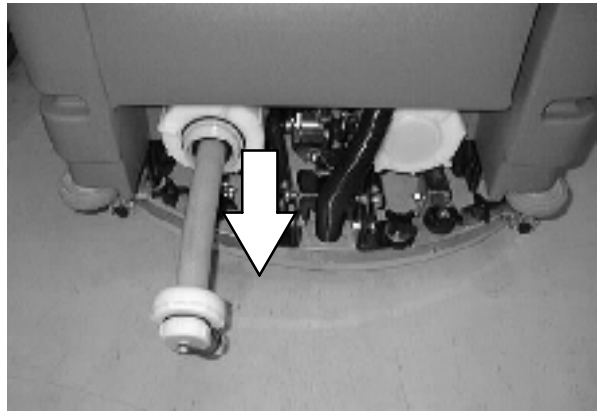

11. ES™ mode (option): Lift the tank cover and flush out the solution tank with clean water. Rinse the filter at the bottom of the solution tank and the pressure switch near the top of the tank.

NOTE: DO NOT use steam to clean the tanks. Excessive heat can damage the tanks and components.

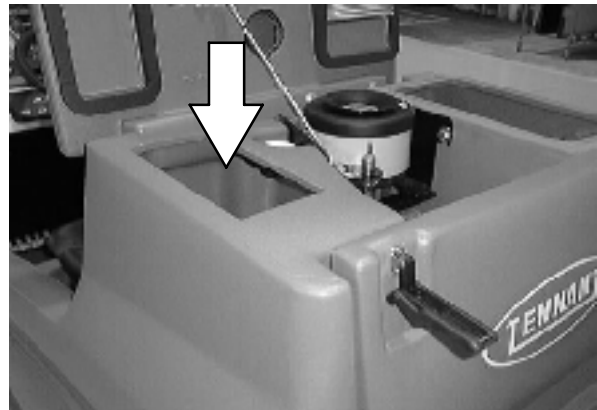

OPERATION

12. ES™ mode (option): When the solution tank has completely drained, replace the drain hose cap on the end of the solution tank drain hose. Slide the hose assembly back into the machine and secure by tightening the retaining ring.

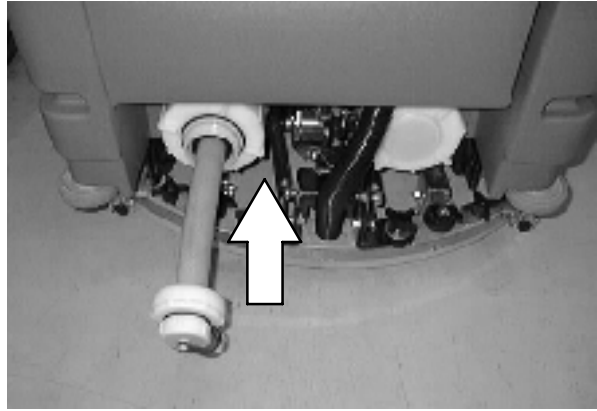

13. Check the vacuum fan inlet filter daily. Clean inlet filter with a damp cloth or hose when dirty. Allow filter to dry completely before replacing it into machine.

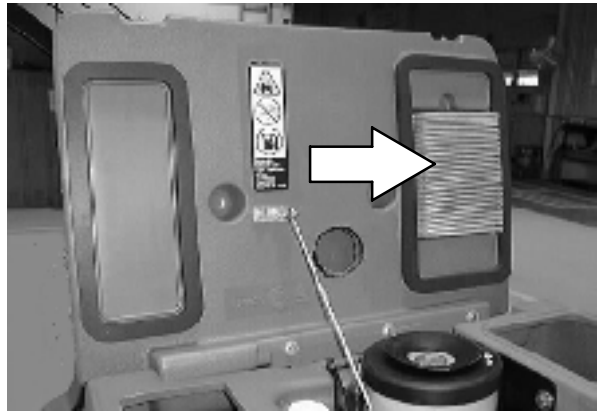

14. Lower the tank cover.

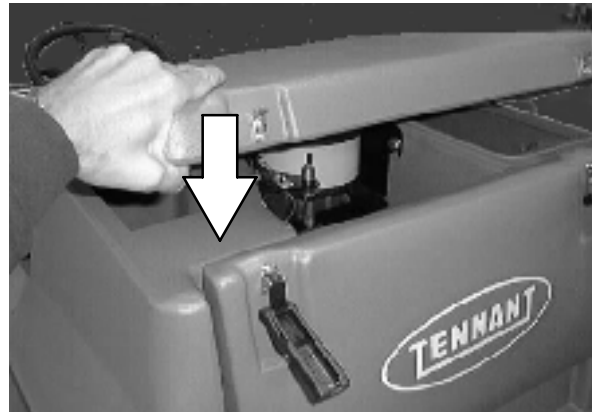

15. Cylindrical scrub head: Lower the scrub head approximately 25mm (1 in). Remove the cotter pin that holds the side squeegee in place on the right hand side of the machine. Swing the squeegee away from the scrub head.

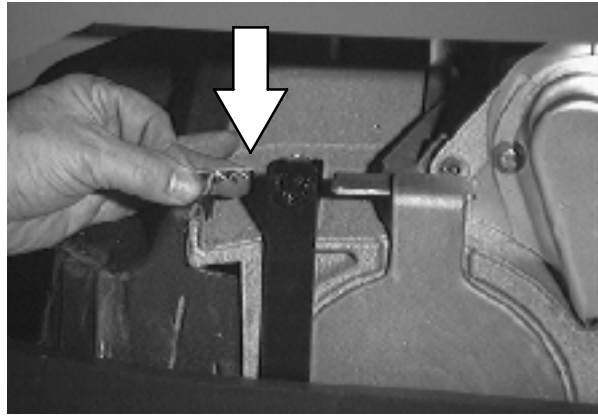

16. Cylindrical scrub head: Remove and clean the debris trough. Place the trough back in the scrub head when clean.

NOTE: The scrub head must be lowered approximately 25 mm (1 in) to remove debris trough.

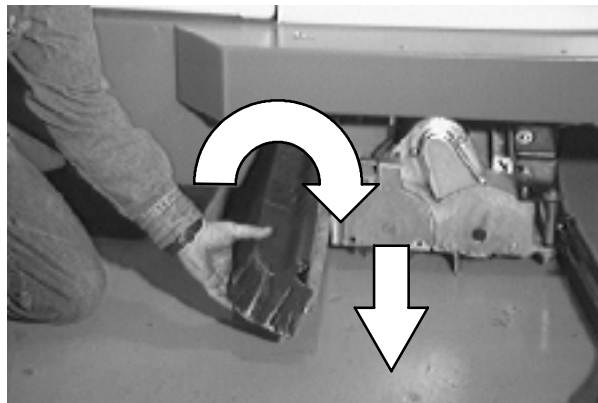

OPERATION

STOP THE MACHINE

1. Stop scrubbing. See the STOP SCRUBBING section of the manual.
2. Take your foot off the *directional pedal*. Step on the *brake pedal*.

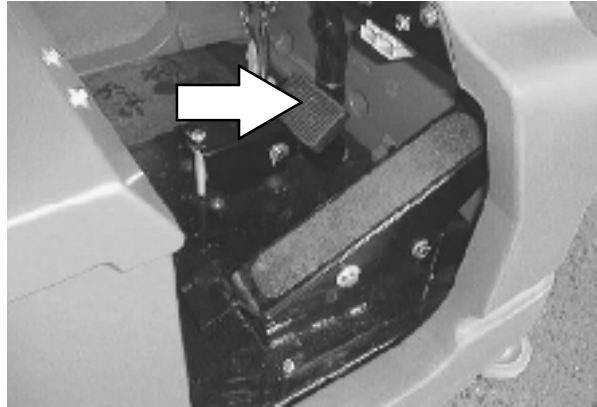

3. Turn the machine power off.



4. Set the machine parking brake.

FOR SAFETY: Before leaving or servicing machine, stop on level surface, set parking brake, turn off machine, and remove key.

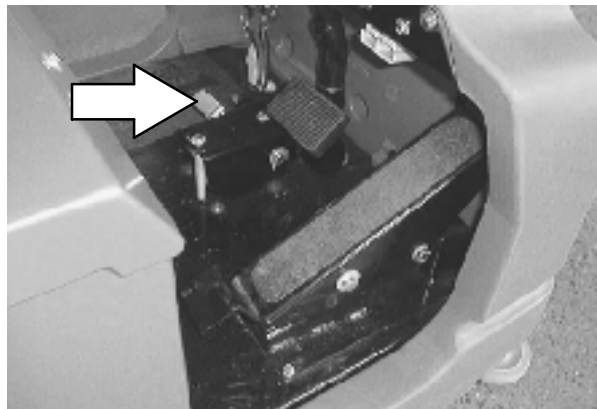

POST-OPERATION CHECKLIST

- Check the battery charge level.

NOTE: The reading on the battery discharge indicator may not be accurate when the machine is first powered on. Operate the machine a few minutes before reading the charge level of the batteries.

- Check for wire, string, or twine wrapped around the scrub brushes.
- Check the squeegees for wear or damage.
- Check the squeegee suction hose for obstructions.
- Cylindrical brushes: Empty and clean the debris tray.
- Drain and clean the recovery tank.
- Clean the vacuum fan inlet filter.
- ES™ machines. Drain and clean the solution tank and ES™ filter.
- Check under the machine for leaks.
- Check the service records to determine maintenance requirements.
- FaST™ scrubbing: If FaST™ PAK is empty after scrubbing, install the new FaST PAK or connect the supply hose to the storage plug.

OPTIONS

POWER WAND

The *power wand* uses the machine's vacuum and solution systems. The *power wand* is designed to scrub narrow or partially enclosed areas of the floor.

⚠ WARNING: Flammable materials or reactive metals can cause explosion or fire. Do not pick up.

1. Turn the machine power off.

FOR SAFETY: Before leaving or servicing machine, stop on level surface, and turn off machine.



2. Set the machine parking brake.

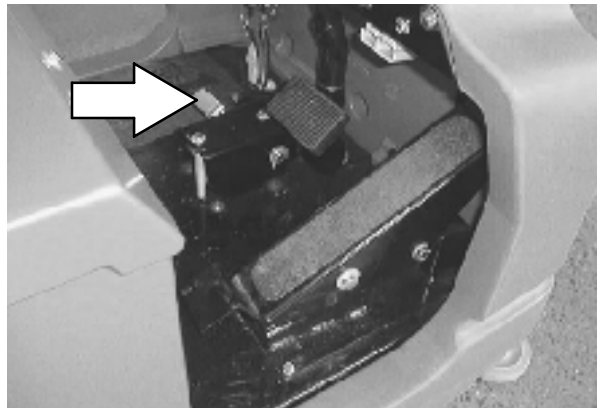

3. Remove the *power wand* equipment from the storage bag on the back of the machine.

4. Remove the squeegee suction hose from the top of the squeegee.

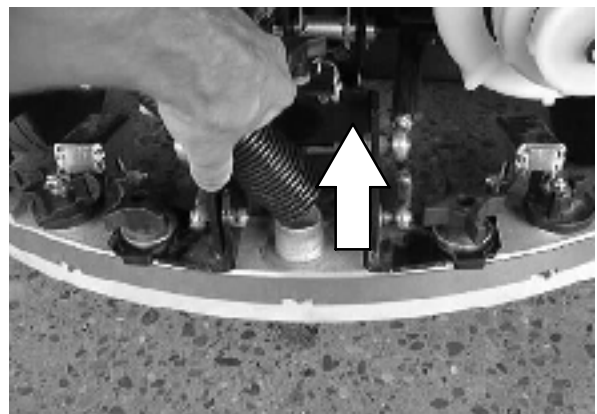

5. Connect the vacuum wand hose and the squeegee suction hose with the adapter.

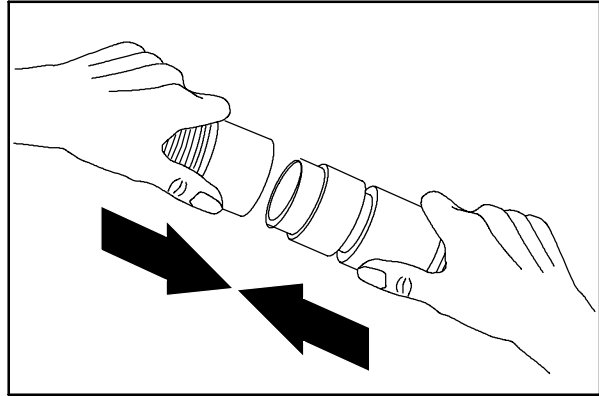

10945

6. Attach the end of the *power wand* solution hose to the quick-disconnect. Push the connector in until it stops. Pull on the hose to make sure it is connected.

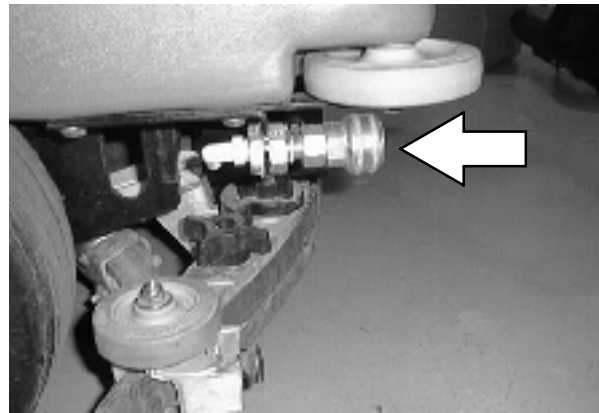

7. Assemble the *power wand*, and attach the other ends of the solution and vacuum hoses to the *power wand*.

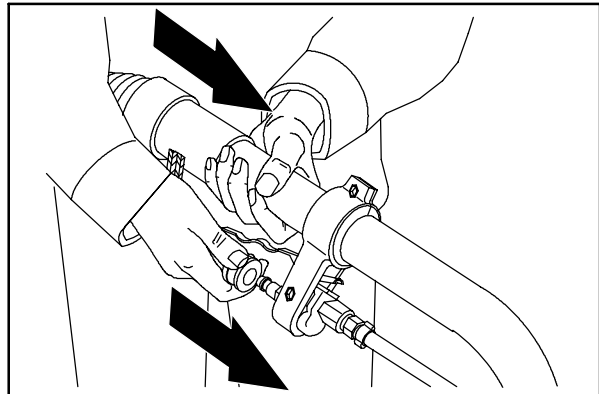

07320

8. Turn the machine power on.

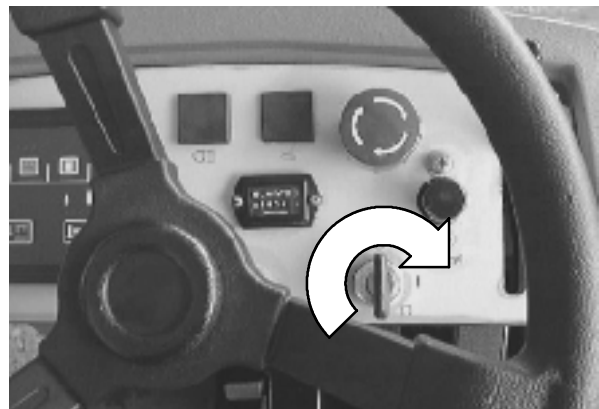

OPERATION

9. Press the *squeegee switch* to start the vacuum.

NOTE: The rear squeegee will also lower.

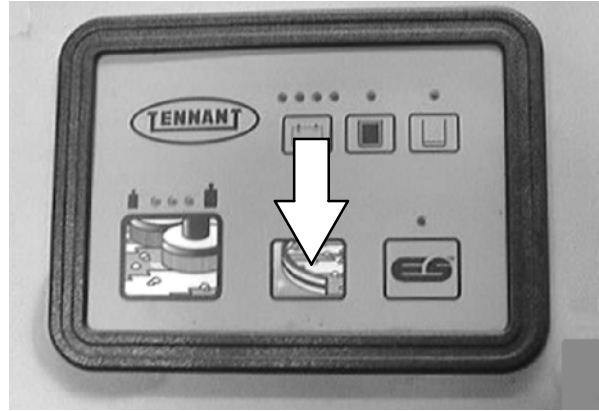

10. Press the top of the *power wand switch* to turn the power wand on.



11. Squeeze the solution lever on the *power wand* to spray solution on the floor. Scrub the floor with the brush side of the cleaning tool.

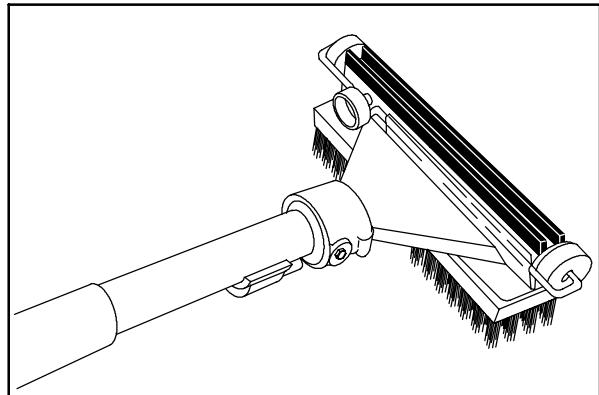

12. Vacuum up the solution by turning over the cleaning tool so the squeegee side is down.

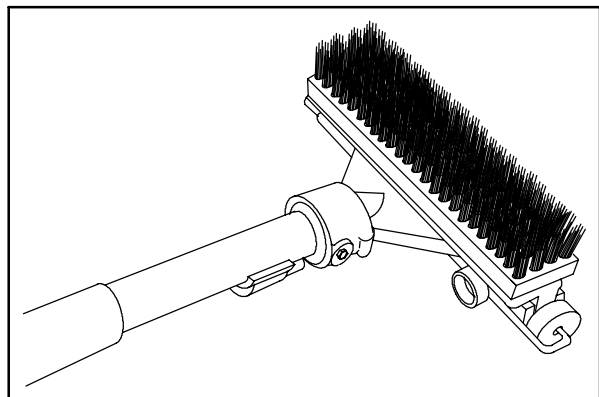

If the *power wand* is hard to push or is not picking up the solution very well, adjust the roller wheels on the tool by turning the black adjustment knob.

NOTE: The wheels are properly adjusted when the squeegee blades deflect slightly while the tool is pushed back and forth.

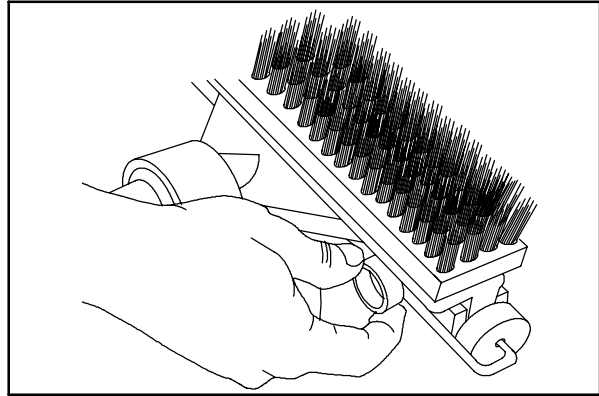

06604

13. When finished, press the bottom of the *power wand switch* to turn off the power wand.



14. Press the *squeegee switch* to stop the vacuum system and raise the rear squeegee.

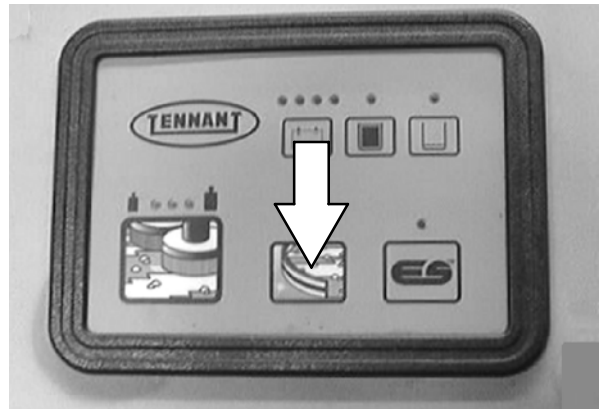

15. Turn the machine power off.



OPERATION

16. Disconnect the solution hose from the machine.

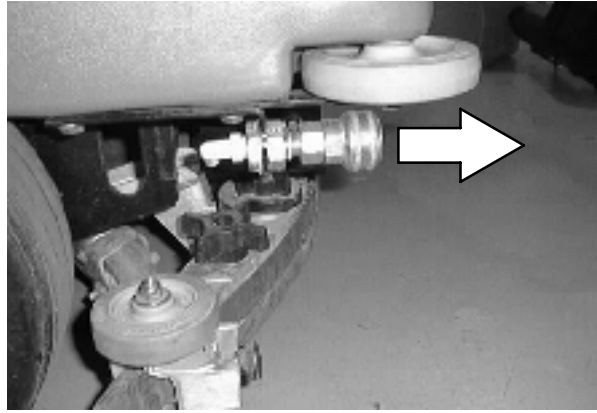

17. Remove the vacuum hose from the squeegee suction hose.

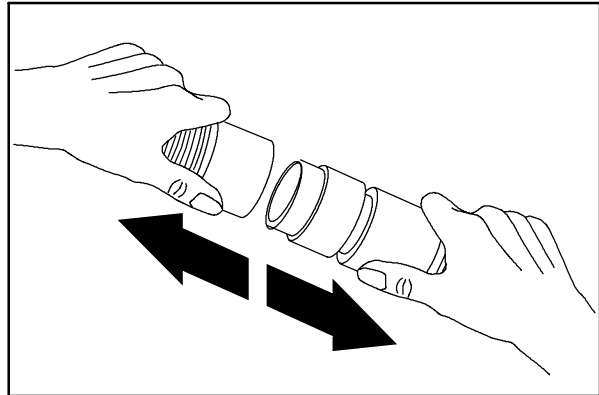

10946

18. Reconnect the squeegee suction hose to the squeegee.

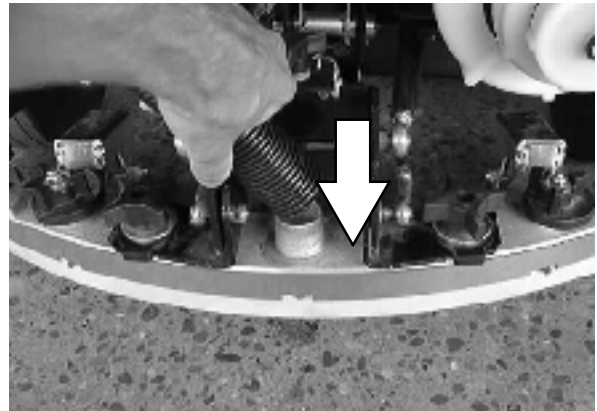

19. Disconnect the other ends of the solution and vacuum hoses from the *power wand*.

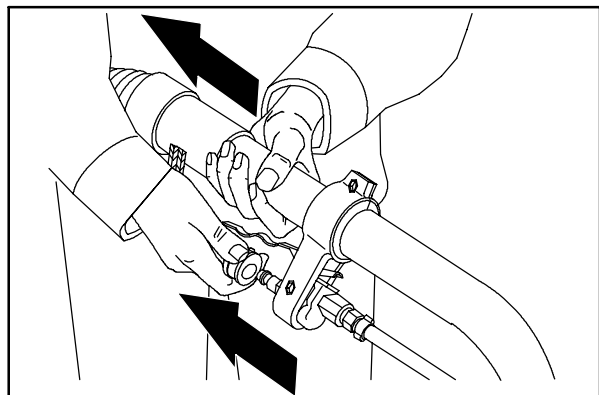

20. Disassemble and secure the *power wand* equipment in the storage bag on the back of the machine.

07321

ROLLOUT BATTERY

The *rollout battery* allows the operator a quick and easy way to remove and replace the batteries from the machine.

1. Drive the machine to a flat, dry surface.
2. Turn the machine power off and set the parking brake.

FOR SAFETY: Before leaving or servicing machine, stop on level surface, set parking brake, turn off machine, and remove key.

3. Lift the operator seat to access the batteries. The support arm automatically engages when the seat is lifted all the way up.
4. Unplug the machine connector from the batteries.

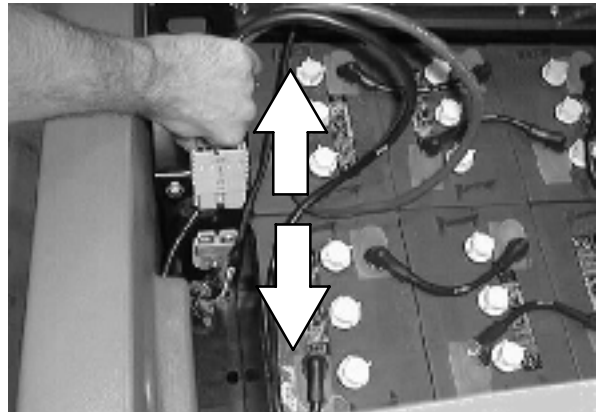

5. Push the battery cart to the right hand side of the machine. Line up the battery cart locks and the tabs on the machine. Push the battery cart forward.

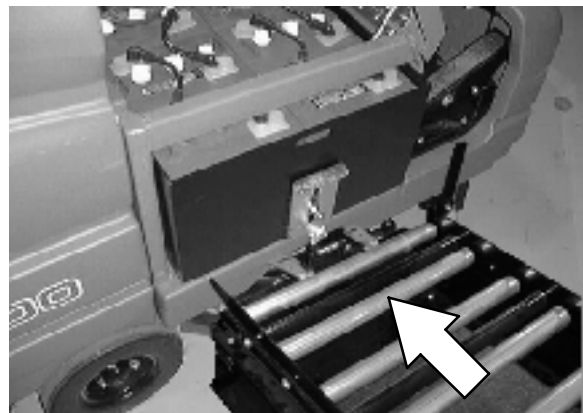

OPERATION

6. Lock the battery cart to the machine by closing the battery cart locks around the machine tabs.

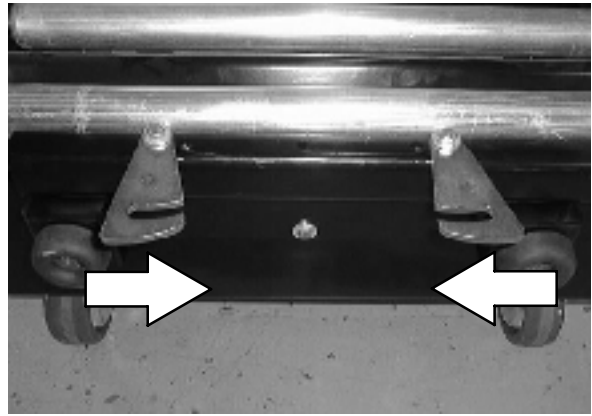

7. Set the battery cart floor lock by stepping down on the left side of floor lock.



8. Adjust the battery cart rollers before rolling out the batteries. The battery cart rollers must be the same height as the machine battery rollers.

Raise battery cart rollers: With a wrench, loosen the jam nut and turn the bolt clockwise. Then tighten the jam nuts.

Lower battery cart rollers: With a wrench, loosen the jam nut and turn the bolt counter-clockwise. Then tighten the jam nuts.

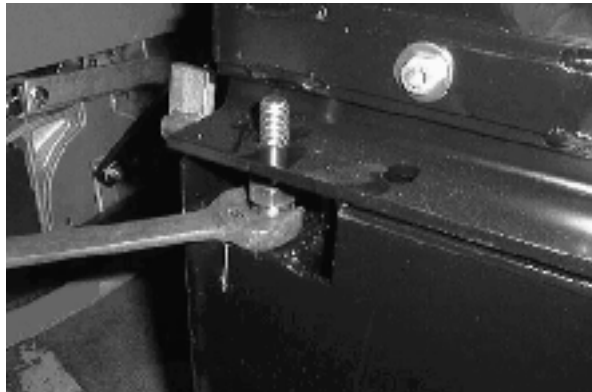

9. Turn the knob on the machine's battery latch plate counter-clockwise until the latch plate is free to move.

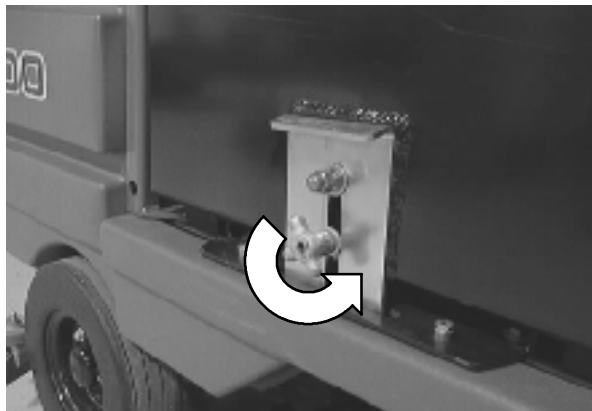

10. Raise the battery latch plate up out of the securing slot.

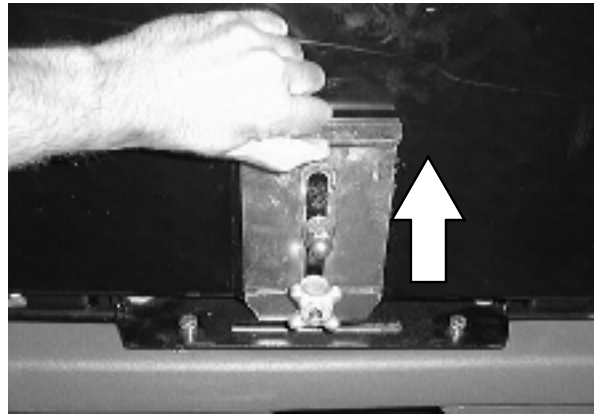

11. Raise the cart's battery stop bar by pushing down on the handle.

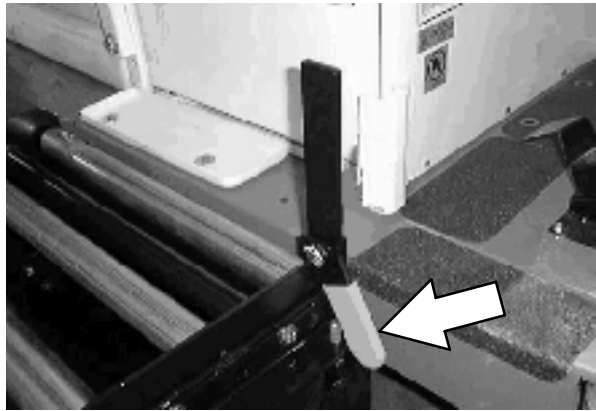

12. Grab the battery case slot and pull the battery case onto the battery cart.

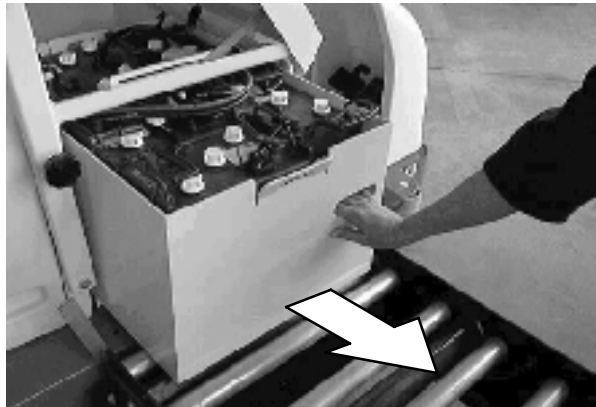

13. Lower the cart's battery stop bar by pulling up on the handle. This will keep the batteries from rolling off the cart when moving.



OPERATION

14. Release the battery cart from the machine by pushing the battery cart locks towards the outside of the battery cart.

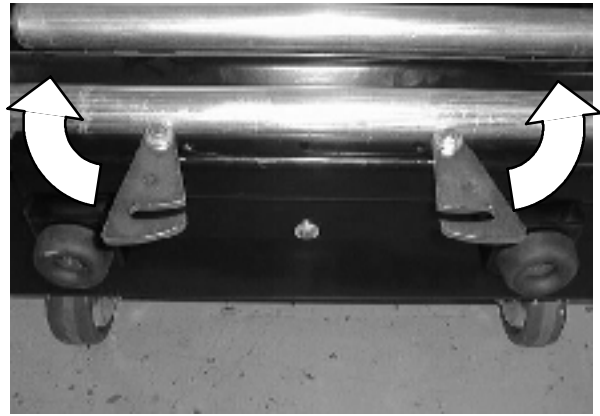

15. Release the battery cart floor lock. To release floor lock, step down on the right side of floor lock.

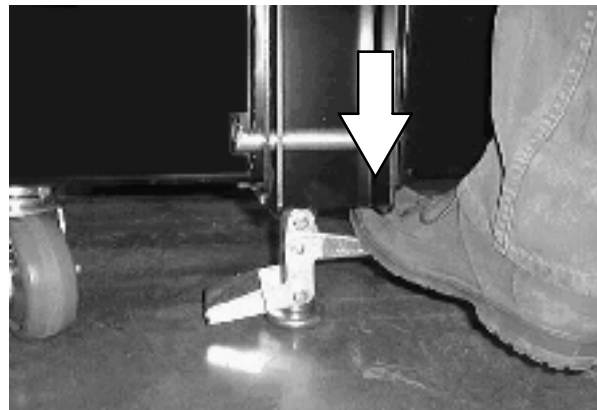

16. Pull the battery cart away from the machine.

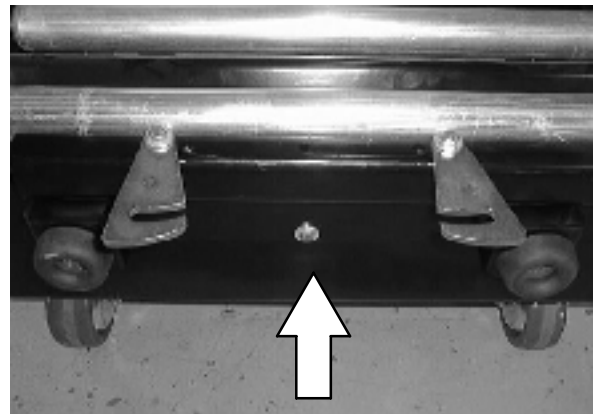

17. Reverse the previous steps to re-install batteries in the machine.

QUICK MOP™

The *QuickMop™* is a front end sweeping attachment that sweeps a clean path on the floor, as the machine scrubs the floor.

1. Drive the machine close to *QuickMop™* attachment.
2. Set the machine parking brake and turn the machine power off.

FOR SAFETY: Before leaving or servicing machine, stop on level surface, set parking brake, turn off machine, and remove key.

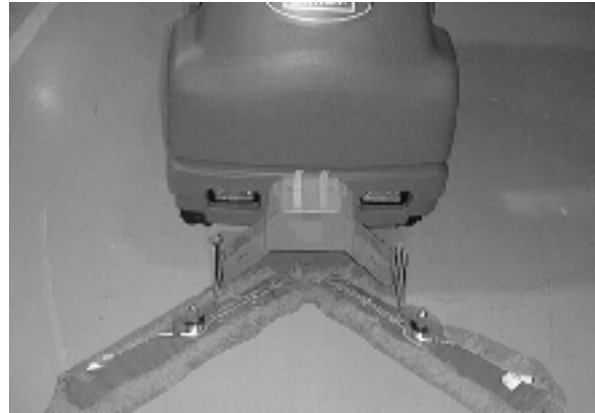

3. Connect the *QuickMop™* attachment to the mounting bracket on the front of the machine.

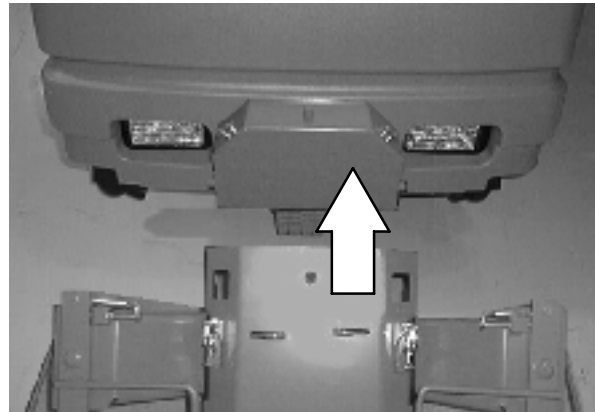

4. Fasten the latches on the front of the mounting bracket. Release the parking brake and drive to the designated area to be swept.

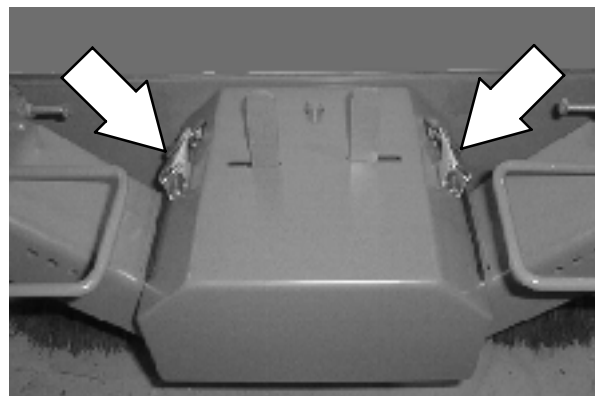

OPERATION

5. Pull the release lever to raise or lower each side of the *QuickMop*™.

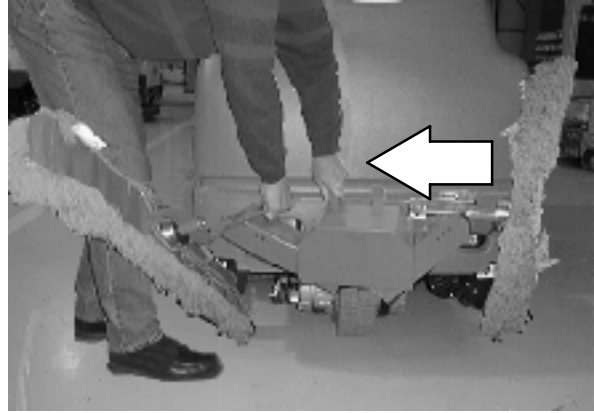

6. Turn the vacuum and brushes on, lower brushes and begin scrubbing.

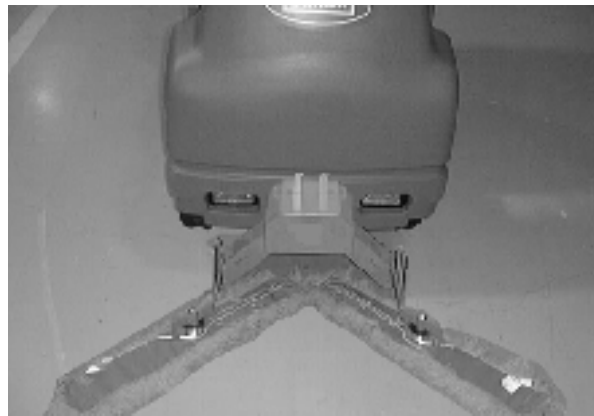

7. Remove and refasten the *QuickMop*™ head covers with the easy to remove snaps. Remove the head covers to rotate, shake and clean at regular intervals.

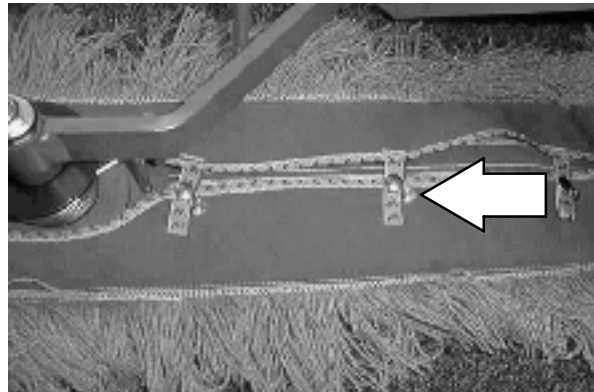

MACHINE TROUBLESHOOTING

Problem	Cause	Remedy
Trailing water – poor or no water pickup	Worn squeegee blades	Rotate or replace squeegee blades
	Squeegee out of adjustment	Adjust squeegee
	Vacuum hose clogged	Flush vacuum hoses
	Vacuum fan inlet filter dirty or wet	Clean and dry inlet filter
	Debris caught on squeegee	Remove debris
	Vacuum hose to squeegee or recovery tank disconnected or damaged	Reconnect or replace vacuum hose
	Tank cover not completely closed	Check for obstructions
	Torn seals on recovery tank	Replace seals
Vacuum fan will not turn on	Recovery tank full	Drain recovery tank
	Foam filling recovery tank	Empty recovery tank
		Use less or change detergent
		Use a defoamer
Vacuum fan circuit breaker tripped	Reset circuit breaker	
Little or no solution flow to the floor	Solution tank empty	Fill solution tank
	Solution control rod broken or out of adjustment	Replace and/or adjust rod
	Solution flow turned off	Turn solution flow on
	Solution supply lines plugged	Flush solution supply lines
	Solution solenoid clogged or stuck	Clean or replace
	ES™ mode (option): ES™ switch off	Turn ES™ switch on
Poor scrubbing performance	Debris caught on scrub brushes	Remove debris
	Improper detergent or brush used	Check with TENNANT representative for advice
	Worn scrub brush(es)	Replace scrub brush(es)
	Scrub brush motor circuit breaker(s) tripped	Reset circuit breaker(s)
		Reduce scrub brush down pressure
		Uneven brush pressure, level scrub head
		Broken brush drive belts on cylindrical scrub head, replace belt
	Check with TENNANT representative for advice	
	Low battery charge	Charge batteries until the charger automatically turns off
FaST™ System (option) does not operate	FaST™ switch is turned off	Turn on the FaST™ switch.
	FaST™ circuit breaker tripped	Determine cause and reset the 10A circuit breaker button
	Clogged FaST™ PAK supply hose and/or connector	Soak connector and hose in warm water and clean
	FaST™ PAK carton is empty or not connected	Replace FaST™ PAK carton and/or connect supply hose
	FaST™ system is not primed	To prime, operate the FaST™ solution system for 5 to 10 minutes.
	Clogged flow control orifice/screen	Remove and clean orifice/screen
	Faulty pump or air compressor	Contact Tennant representative
	Clogged filter screen	Drain solution tank, remove and clean filter screen
	Faulty detergent timer module	Contact Tennant representative

MAINTENANCE

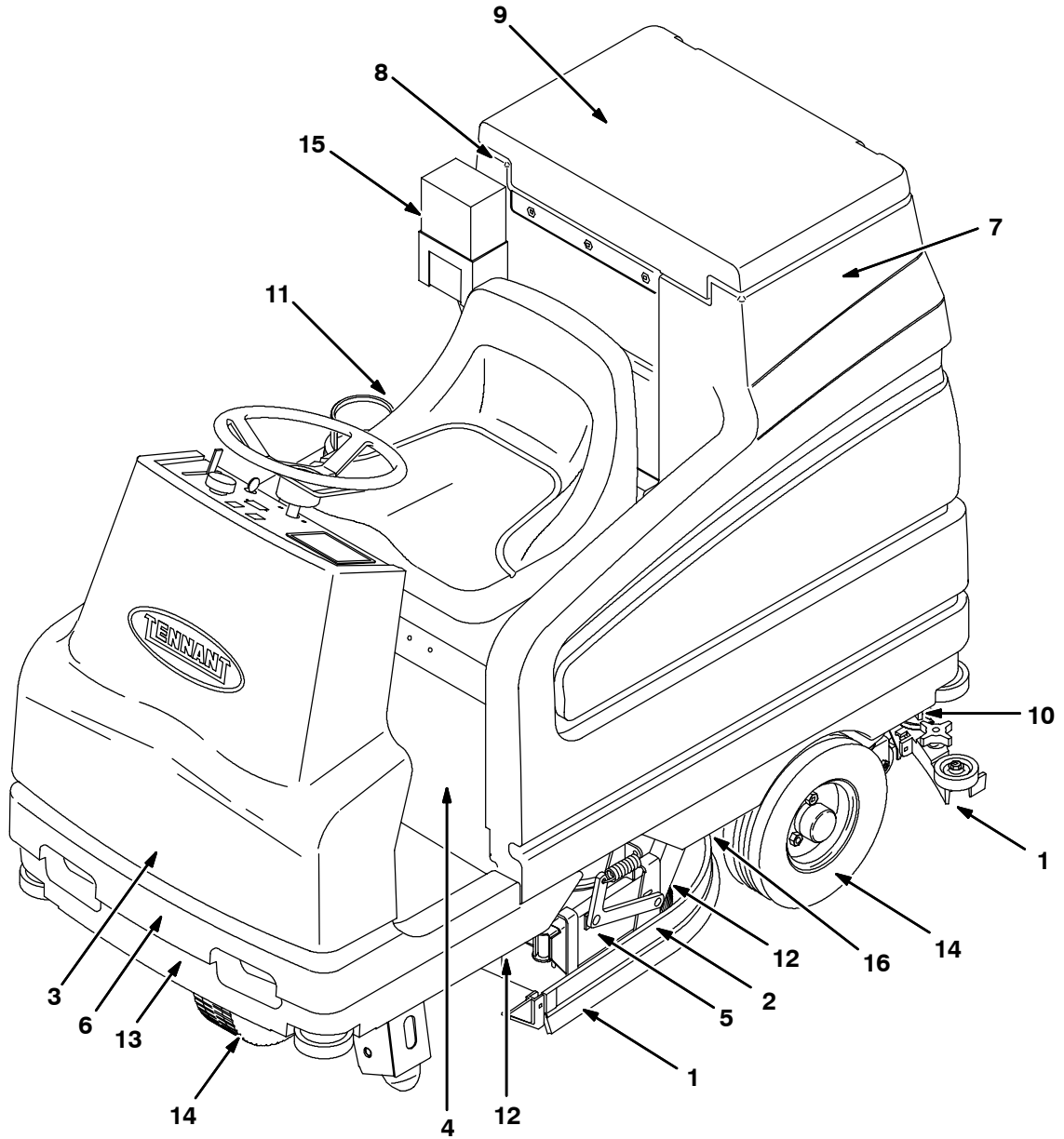

353450

MAINTENANCE CHART

NOTE: Check procedures indicated (■) after the first 50 hours of operation.

Interval	Key	Description	Procedure	Lubricant/Fluid	No. of Service Points
Daily	1	Side and rear squeegees	Check for damage and wear	-	3
			Check deflection and leveling	-	6
	2	Scrub brushes	Check for damage, wear, debris	-	2
	8	Recovery tank	Clean tank	-	1
	8	Recovery tank, ES™ mode	Clean ES™ filter	-	1
	7	Solution tank, ES™ mode	Clean solution supply filter	-	1
	9	Vacuum fan inlet filter	Clean	-	1
	-	Machine	Check for leaks	-	3
		11	Cylindrical brushes only: debris trough	Clean	-
	15	FaST™ PAK supply hose and connector (option)	Clean and connect hose to storing plug when not in use	-	1
50 Hours	5	Cylindrical brushes	Check taper and rotate front to rear	-	2
	10	Squeegee caster wheels and pivot points	Lubricate	SPL	4
	4	Battery cells	Check electrolyte level	DW	3
	12	Disk scrub head floor skirts	Check for damage and wear	-	2
	16	FaST™ filter screen (option)	Clean	-	1
100 Hours	5	Cylindrical scrub brush drive belts	Check tension	-	2
	3	Steering caster pivot bearing	Lubricate	SPL	1
	5	Scrub head lift bearings (option)	Lubricate	SPL	2
	9	Vacuum Fan and tank seals	Check for damage and wear	-	3
	14	Tires	Check for damage and wear	-	3
200 Hours	4	Battery terminals and cables	■Check and clean	-	12
	13	Brake	Check adjustment	-	1
	6	Steering gear chain	Lubricate	GL	1
	16	FaST™ air filter (option)	Clean	-	1
500 Hours	9	Vacuum fan motor(s)	Check motor brushes	-	1 (2)
	3	Steering gear chain	■Check deflection	-	1
1000 Hours	5	Scrub brush motors	Check motor brushes	-	2
	6	Propelling motor	Check motor brushes	-	1

LUBRICANT/FLUID

DW Distilled water

SPL . . . Special lubricant, Lubriplate EMB grease (TENNANT part no. 01433-1)

GL SAE 90 weight gear lubricant

LUBRICATION

STEERING CASTER PIVOT BEARING

The steering caster bearing is located on the bottom of the swivel plate, above the steering gear chain sprocket. Lubricate with Lubriplate EMB grease (TENNANT part no. 01433-1) every 100 hours.

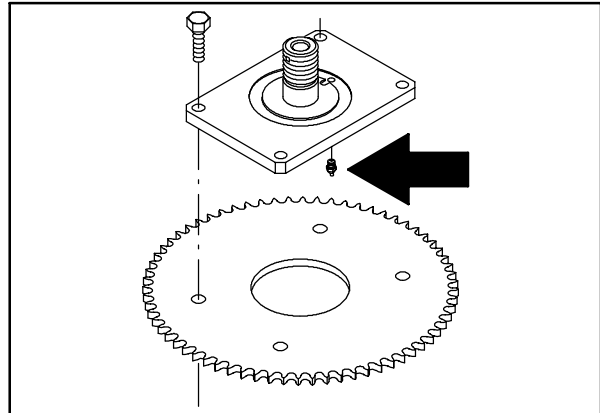

REAR SQUEEGEE CASTERS

The rear squeegee casters are located on the back side of the rear squeegee. Lubricate the caster bearing on each squeegee caster with Lubriplate EMB grease (TENNANT part no. 01433-1) every 50 hours.

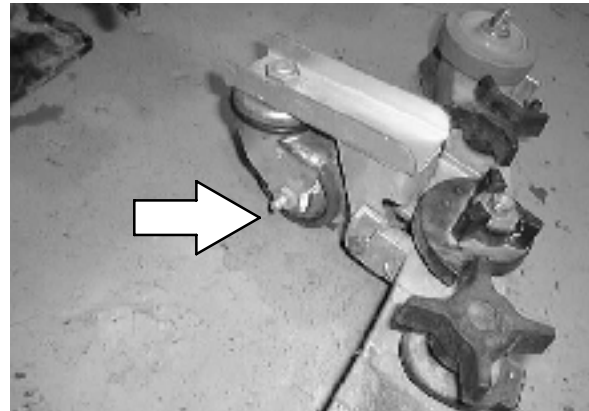

STEERING GEAR CHAIN

The steering gear chain is located directly above the front tire.

Lubricate with SAE 90 weight gear lubricant every 200 hours of use.

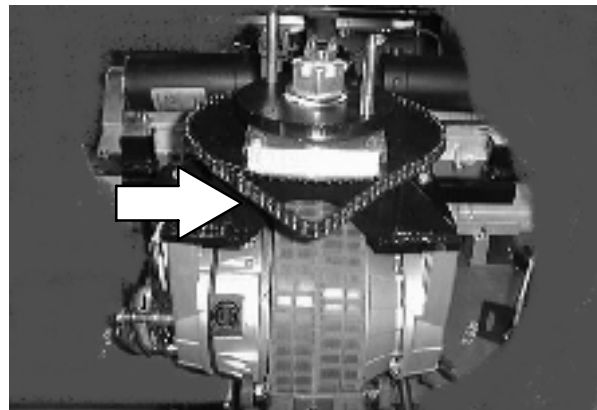

SCRUB HEAD LIFT BEARINGS (OPTION)

The scrub head lift bearings are located on the scrub head lift arms for the battery rollout option. Each bearing has one grease fittings. Lubricate the bearing on each side of the lift arms with Lubriplate EMB grease (TENNANT part no. 01433-1) after every 100 hours of operation.

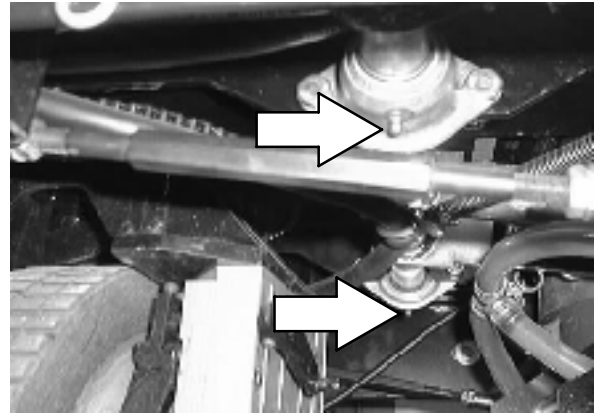

BATTERIES

The batteries are designed to hold their power for long periods of time. The lifetime of the batteries is limited to number of charges the batteries receive. To get the most life from the batteries, recharge them immediately when the battery discharge indicator begins to blink.

After every 200 hours of use check for loose battery connections and clean the surface of the batteries, including terminals and cable clamps, using a strong solution of baking soda and water. Brush the solution sparingly over the battery tops. Do not allow any baking soda solution to enter the batteries. Use a wire brush to clean the terminal posts and the cable connectors. Wipe off all cleaning solution residue. After cleaning, apply a coating of clear battery post protectant to the terminals and the cable connectors. Keep the tops of the batteries clean and dry.

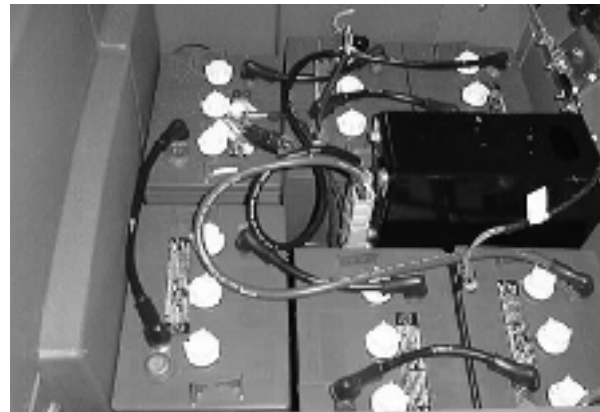

Objects made of metal can potentially short circuit the batteries. Keep all metallic objects off the batteries. Replace any worn or damaged wires.

Check the electrolyte level in each battery cell before and after charging, and after every 50 hours of operation. Never add acid to the batteries. Add distilled water *only*. Always keep the battery caps on, except when adding water or taking hydrometer readings.

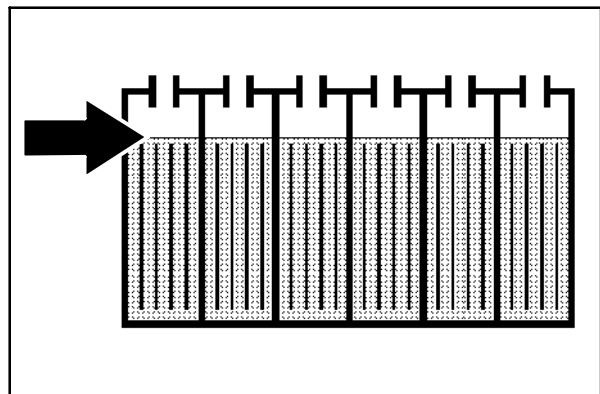

MAINTENANCE

Using a hydrometer, measure the specific gravity to determine the charge level and condition of the batteries. If one or more of the battery cells test lower than the other battery cells (0.050 or more), the cell is damaged, shorted, or is near failure. Completely recharge the batteries, then retest them.

NOTE: Do not take readings immediately after adding distilled water. If the water and acid are not thoroughly mixed, the readings may not be accurate. Check the hydrometer readings against the following chart to determine the remaining battery charge level:

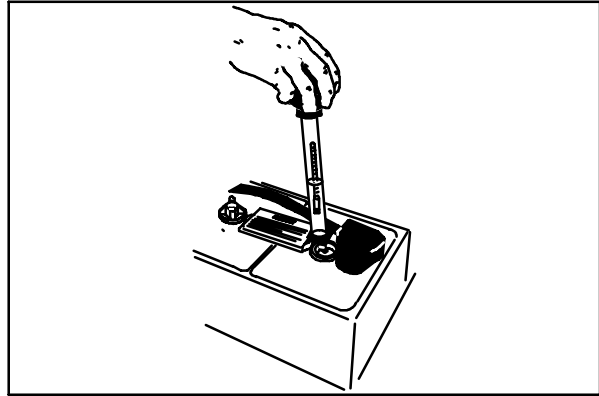

04380

SPECIFIC GRAVITY at 27° C (80° F)	BATTERY CHARGE
1.265	100% Charged
1.223	75% Charged
1.185	50% Charged
1.148	25% Charged
1.110	Discharged

NOTE: If the readings are taken when the battery electrolyte is any temperature other than 27° C (80° F), the reading must be temperature corrected. Add or subtract to the specific gravity reading 0.004, 4 points, for each 6° C (10° F) above or below 27° C (80° F).

CHARGING THE BATTERIES

1. Drive the machine to a flat, dry surface.

NOTE: Make sure the area is well ventilated.

2. Turn the machine power off and set the parking brake.

FOR SAFETY: Before leaving or servicing machine, stop on level surface, set parking brake, turn off machine, and remove key.

3. Lift the operator seat to access the batteries. The support arm automatically engages when the seat is lifted all the way up.

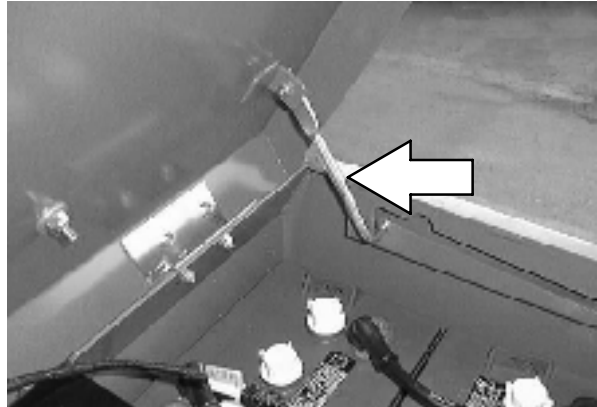

4. Check the water level in all battery cells. If the level is low, add just enough distilled water to cover the plates. **DO NOT OVERFILL.** The batteries can overflow during charging due to expansion.

NOTE: Make sure the battery caps are in place while charging.

FOR SAFETY: When maintaining or servicing machine, avoid contact with battery acid.

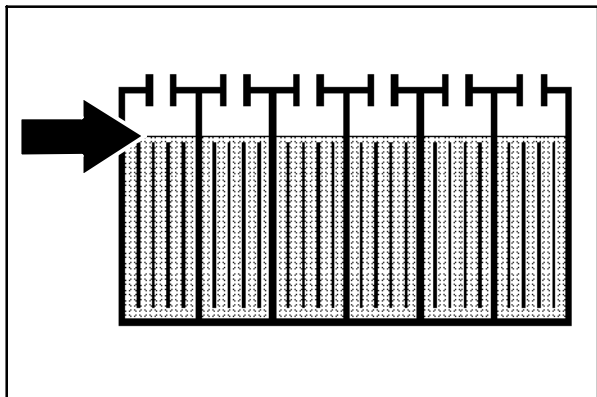

5. Plug the charger connector into the machine connector.



WARNING: Batteries emit hydrogen gas. Explosion or fire can result. Keep sparks and open flame away. Keep covers open when charging.

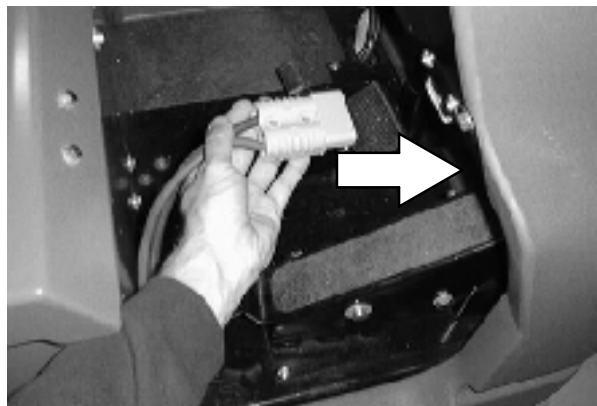

MAINTENANCE

6. Plug the battery charger into the wall outlet.

NOTE: If the red "ABNORMAL CYCLE" lamp lights when the TENNANT charger is plugged into a wall outlet, the charger cannot charge the battery and there is something wrong with the battery.

7. The TENNANT charger will start automatically. When the batteries are fully charged, the TENNANT charger will automatically turn off.
8. After the charger has turned off, unplug the charger from the battery connector on the machine.

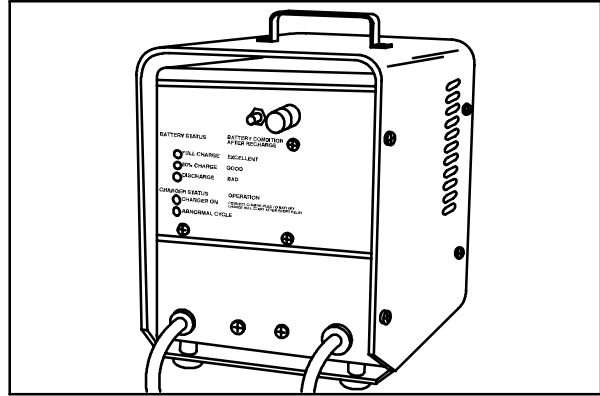

07224

9. Reconnect the battery connector to the machine connector.

FOR SAFETY: When maintaining or servicing machine, avoid contact with battery acid.

10. Check the electrolyte level in each battery cell after charging. If needed, add distilled water to raise the electrolyte level to about 12 mm (0.4 in) below the bottom of the sight tubes.
11. Lower the seat support by slightly raising it while pushing the support arm inward.



SELF-DIAGNOSTIC TEST

The machine is capable of running a self-diagnostic test of its electrical system and components.

1. Turn the machine power off.
2. Press and hold the squeegee switch while turning the machine power on. Continue holding the squeegee switch until the scrub pressure light #3 is lit. Release the squeegee switch. Press and release the scrub button until only pressure light #3 is on. Press and release the squeegee switch.

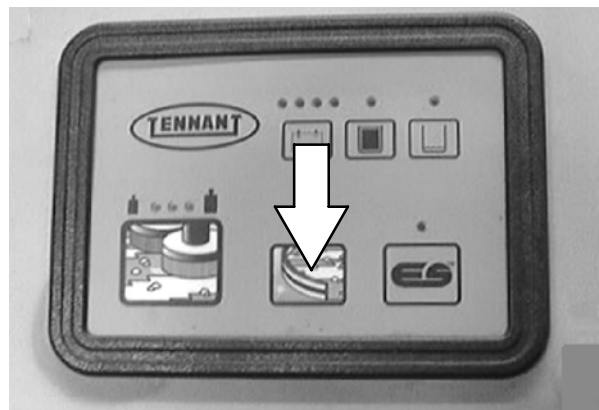

3. The machine systems will activate as follows:
 - The brushes and squeegee raise.
 - The vacuum fan starts and the squeegee lowers. The squeegee raises and the vacuum fan shuts off.
 - The scrub head lowers and raises.
 - The brushes turn on and off.
 - The solution valve turns on and off.
 - If the machine has the ES™ option, the ES™ pump turns on and off.
 - If the machine has the FaST™ option, the FaST™ system turns on and off.
 - The vacuum fan relay is momentarily energized (the vacuum fan does not turn on).
 - The brushes turn on and off.

4. If the electrical system passes the self-diagnostic test, the indicator light above the squeegee switch will blink (green).

If the self-diagnostic test finds an error in the system, the recovery tank full indicator will blink (red).

To determine which errors were found, hold down the ES™ or FaST™ switch and record which, if any, of the brush down pressure indicators illuminate or blink. Repeat this operation with the squeegee switch and the scrubbing switch. Be sure to record which pressure indicators illuminate or blink when each switch is held down.

Contact service personnel with the error code data.

5. Turn off the self-diagnostic test by turning off the machine power.

ELECTRIC MOTORS

The carbon brushes on the vacuum fan motor(s) should be inspected after every 500 hours of machine operation. The carbon brushes on the scrub brush motors and propelling motor should be inspected after every 1000 hours of machine operation.

SCRUB BRUSHES AND PADS

The machine can be equipped with either *disk* or *cylindrical* scrub brushes, or cleaning pads. Check scrub brushes daily for wire or string tangled around the brush or brush drive hub. Also check for brush damage and wear.

DISK BRUSHES

The disk brushes should be replaced if a large number of bristles are missing or if bristle length is less than 10 mm (0.38 in).

Cleaning pads must be placed on pad drives before they are ready to use. The cleaning pad is held in place by a pad holder.

Cleaning pads need to be cleaned immediately after using with soap and water. Do not wash the pads with a pressure washer. Hang pads, or lie pads flat to dry.

NOTE: Be sure to replace brushes and pads in sets. Otherwise one brush or pad will be more aggressive than the other.

REPLACING THE DISK BRUSHES OR PADS

1. Raise the scrub head.
2. Turn the machine power off and set the parking brake.

FOR SAFETY: Before leaving or servicing machine, stop on level surface, set parking brake, turn off machine, and remove key.

3. Remove the cotter pin and washer holding the side squeegee in the closed position.

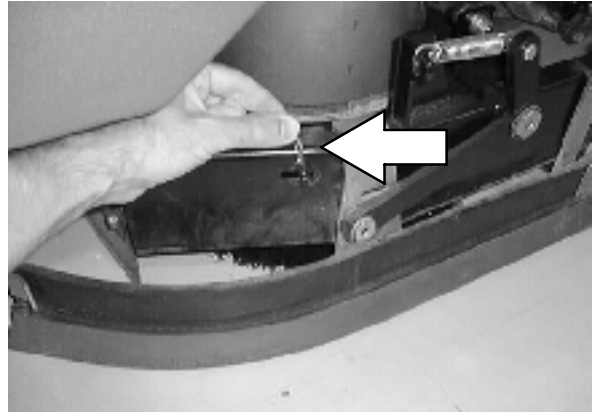

4. Open the side squeegee.

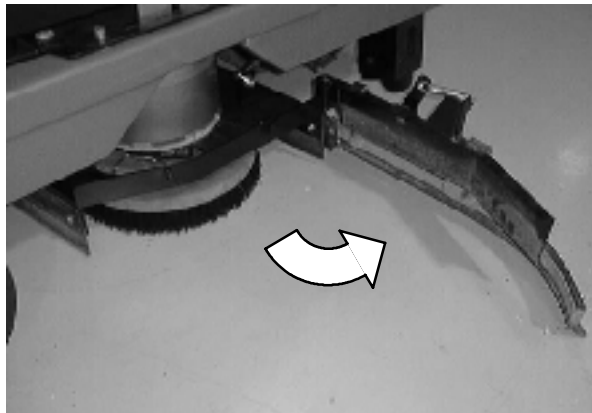

5. Turn the scrub brush/pad driver, until you can see the brush/driver spring clip.

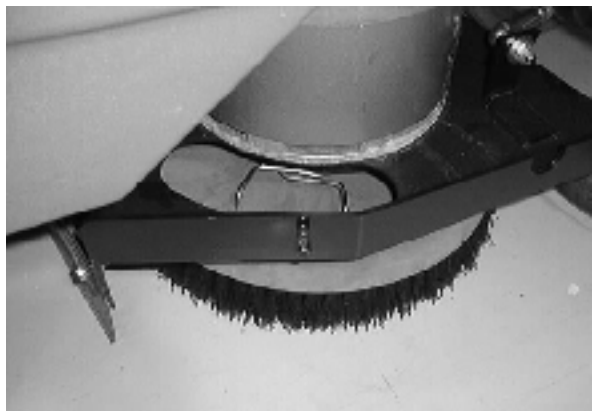

MAINTENANCE

6. Press the brush/driver spring clip together with your thumb and index finger. The scrub brush/pad driver will drop off the drive hub. Pull the brush/driver out from under the scrub head.

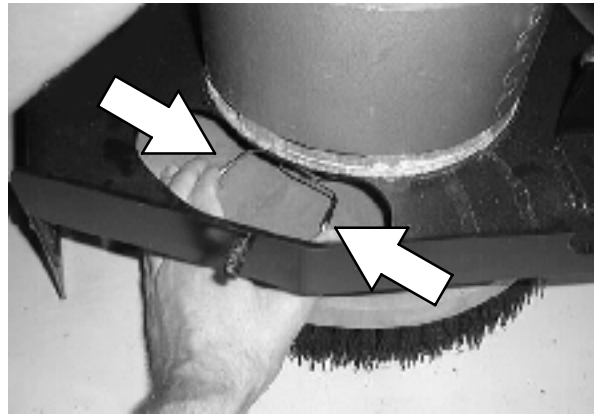

7. PAD DRIVER ONLY: Turn the pad driver over to access the spring clip underneath.

8. Press the spring clip together with your thumb and index finger to remove the center disk.

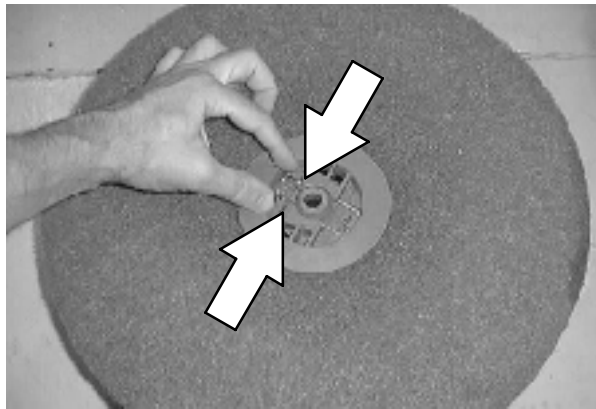

9. Flip or replace the scrub pad, center the scrub pad on the pad driver.

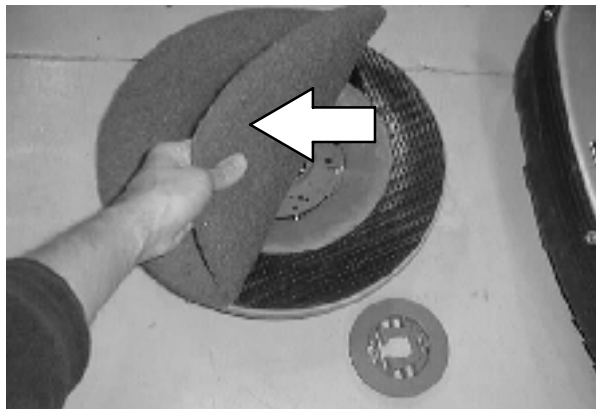

10. Replace the center disk to secure the pad in place on the driver.



11. Place the new scrub brush/pad driver on the floor to the side of the scrub head. Push the brush under the scrub head.

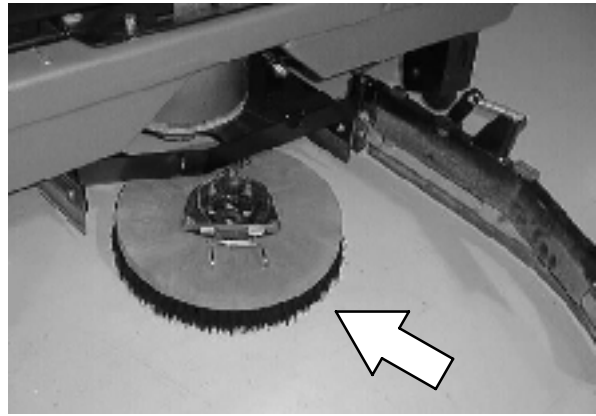

12. Line up the brush /pad driver socket with the drive plug.

13. While pressing the brush spring clip together with your thumb and index finger, lift the scrub brush onto the drive plug.

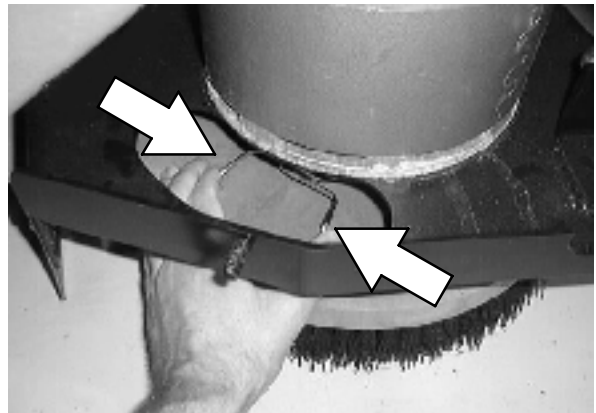

14. Check to make sure the brush is securely mounted on the brush drive hub.

15. Close the side squeegee, and secure in place with the washer and cotter key.

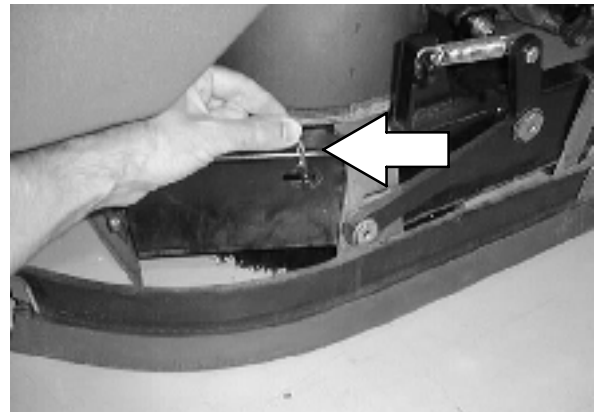

16. Repeat for the other brush.

CYLINDRICAL BRUSHES

Check the brush taper and rotate the brushes from front-to-rear every 50 hours of machine operation for maximum brush life and best scrubbing performance.

The cylindrical brushes should be replaced if large amounts of bristles are missing, or if the remaining bristle length is less than 10 mm (0.38 in).

NOTE: Replace worn brushes in pairs. Scrubbing with brushes of unequal bristle length will result in diminished scrubbing performance.

NOTE: Fill the solution tank before checking or adjusting the brush pattern.

CHECKING AND ADJUSTING CYLINDRICAL BRUSH PATTERN

1. Apply chalk (or another material that will not easily blow away), to a smooth, level section of the floor.
2. Set the parking brake.

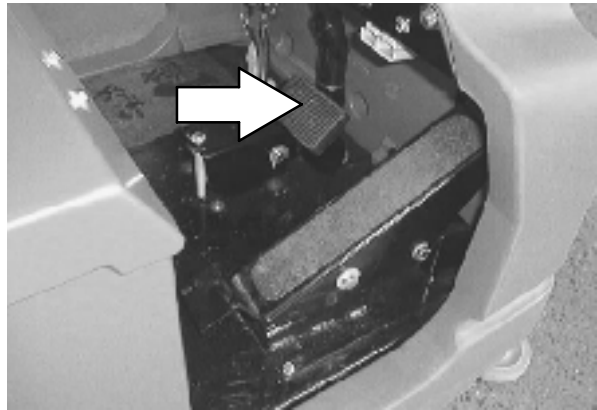

3. Lower the scrub head in the chalked area. Allow the machine to scrub in the same place for 15 to 20 seconds.

NOTE: If chalk or other material is not available, allow the brushes to spin on the floor for two minutes. A polish mark will remain on the floor.

4. Raise the scrub head and move the machine away from the chalked area. Turn the machine power off.

5. Observe the shape of the brush patterns. If the brush patterns have parallel sides, the brushes do not need adjustment.

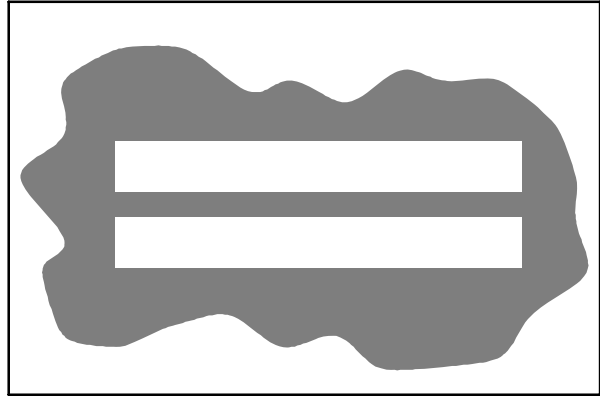

10355

If one, or both of the brush patterns are tapered, the brushes need adjustment to straighten the brush pattern.

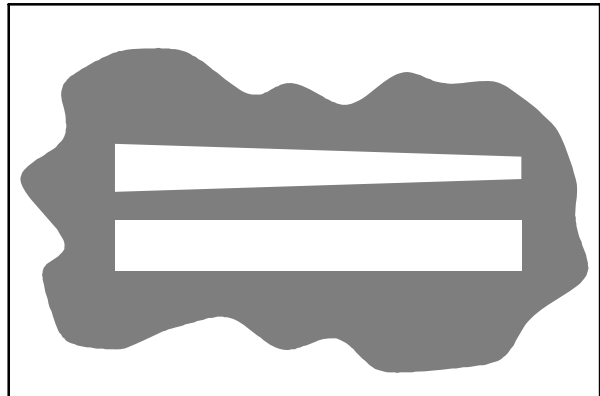

10356

- A. To adjust brush taper, push downward on the mounting spring and idler door until the top of the door releases from the scrub head. Pull the bottom of the door outward, then pull the idler door and idler plug off the brush.

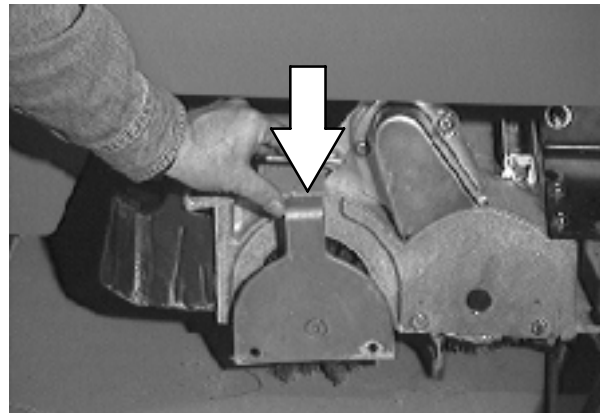

- B. While holding the flat end of the idler shaft with a wrench, loosen the mounting screw on the outside of the idler door.



MAINTENANCE

- C. Turn the idler shaft to raise or lower the end of the brush as needed to straighten the brush pattern. Tighten the mounting screw.
- D. Check the brush patterns again and readjust as necessary until both patterns are the same.

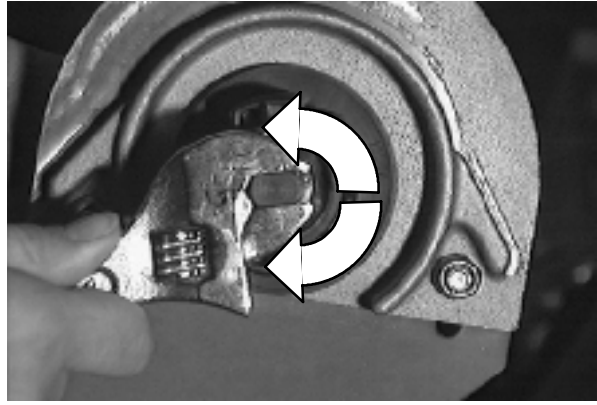

- 6. If one brush pattern is wider than the other, the scrub head needs to be leveled.

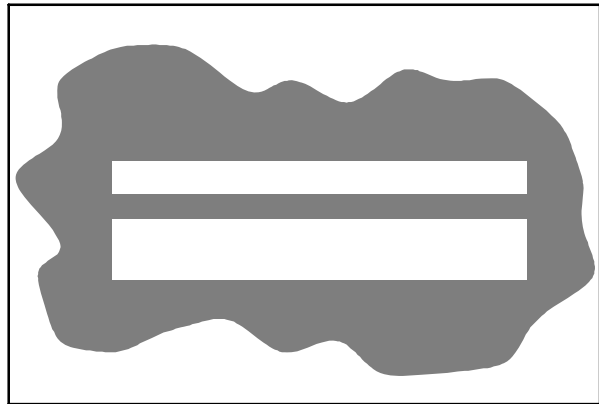

350630

Level the scrub head by turning the scrub head links. Both scrub head links should be adjusted equally.

Check the brush patterns again and readjust as necessary until both patterns are the same.

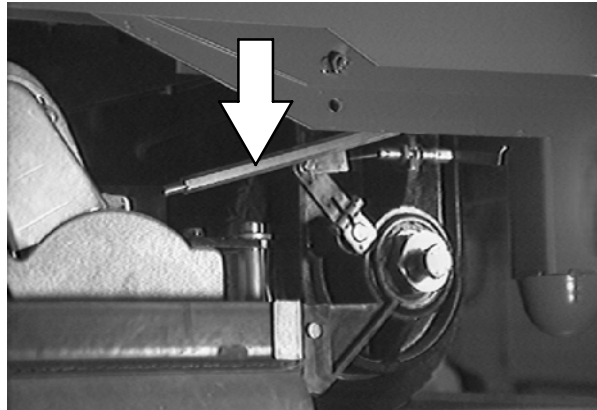

REPLACING THE CYLINDRICAL BRUSHES

1. Press the scrubbing switch. When the scrub head is approximately 25 mm (1 in) from the floor, turn the machine power off.
2. Set the parking brake.

FOR SAFETY: Before leaving or servicing machine, stop on level surface, set parking brake, turn off machine, and remove key.

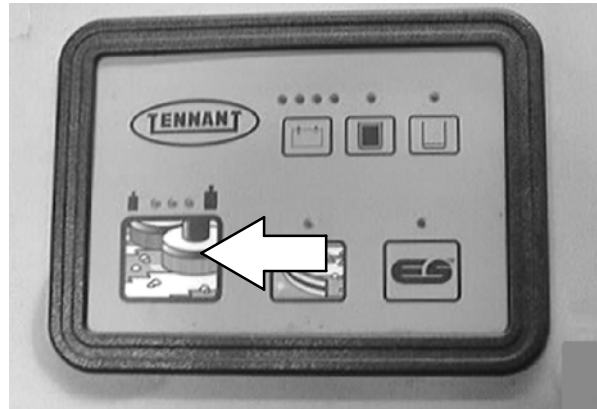

3. Remove the cotter pin that holds the side squeegee in place. Swing the squeegee away from the scrub head.

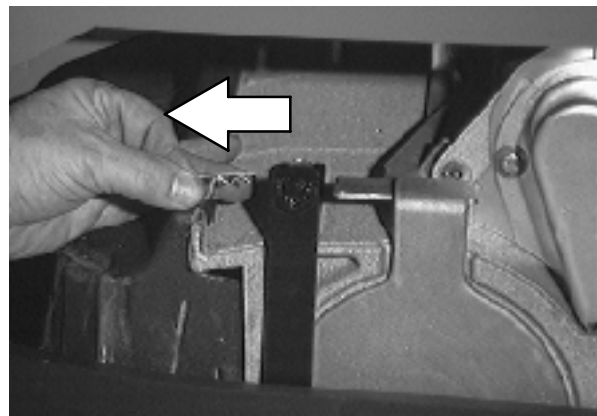

4. Push downward on the mounting spring and idler door until the top of the door releases from the scrub head. Pull the bottom of the door outward, then pull the idler door and idler plug off the brush.

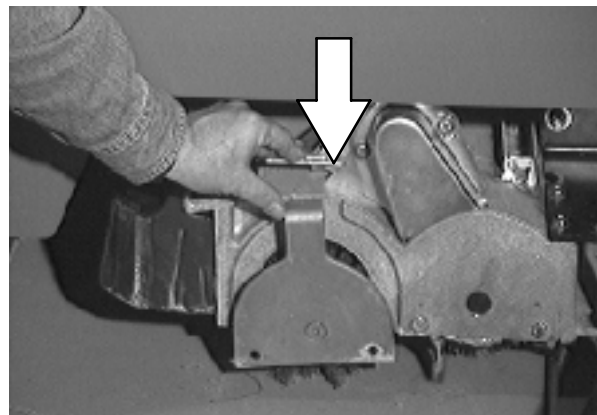

5. Pull the old brush out of the scrub head.

MAINTENANCE

6. Position the brush with the *double row end towards you*. Guide the new brush onto the drive hub.
7. Insert the Idler plug (on the inside of the idler door), into the brush.

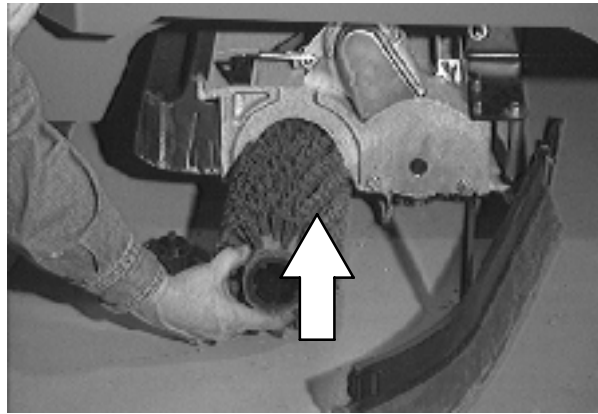

8. Push down on the door to catch the door in the scrub head, then pull up on the door to latch it into the spring.
9. Repeat for the other brush on the other side of the scrub head.

NOTE: Each side of the scrub head is stamped with a letter. The idler door of that side of the scrub head is stamped with the same letter. Make sure the letter on the door matches the letter on the scrub head when replacing the doors.

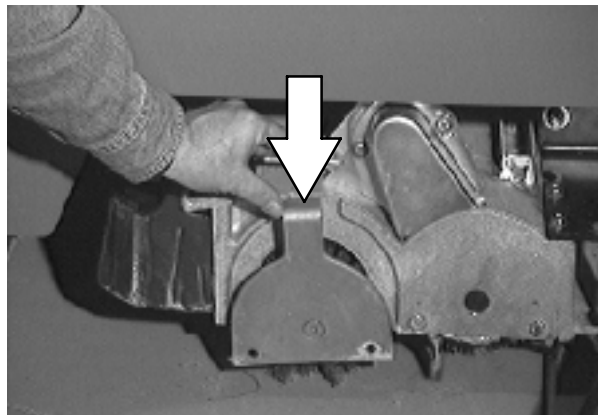

SOLUTION SYSTEM

RECOVERY TANK

The recovery tank holds recovered solution. Clean and drain the recovery tank after each use. The outside of the tank can be cleaned with vinyl cleaner.

ES™ mode: Flush out the recovery tank with clean water after each use.

*NOTE: **DO NOT** use steam to clean the tanks. Excessive heat can damage the tanks and components.*

Thoroughly rinse the pressure switches inside the recovery tank after each use.

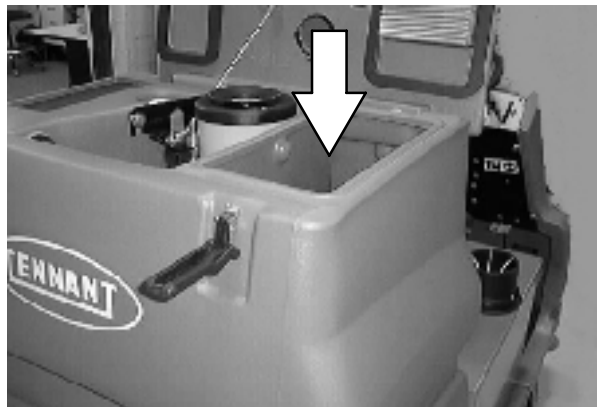

The vacuum fan inlet filter is located above the recovery tank, on the inside of the tank cover.

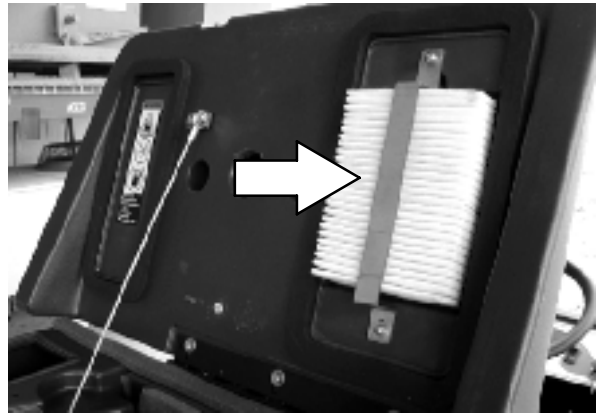

Check the vacuum fan inlet filter daily. Remove the filter bracket to remove and clean the inlet filter. Clean inlet filter with a damp cloth or hose when dirty. Allow filter to dry completely before replacing it into machine.

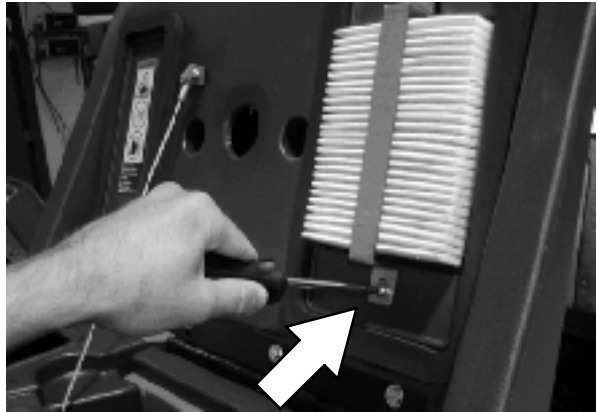

SOLUTION TANK

The solution tank holds the cleaning solution.

If deposits form on the bottom of the tank, rinse the tank and with a strong blast of warm water.

ES™ option: The solution tank should be drained and cleaned daily. Thoroughly rinse the pressure switches inside the recovery tank after each use.

The solution tank contains one standard solution filter. If the filter becomes dirty, the solution flow will be reduced. Check and clean this filter regularly.

NOTE: DO NOT use steam to clean the tanks. Excessive heat can damage the tanks and components.

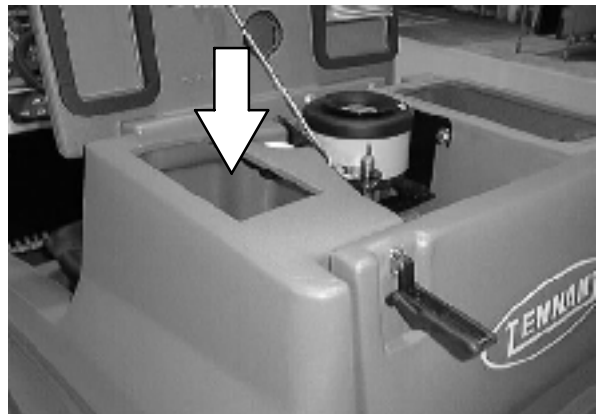

FaST™ SYSTEM (OPTION)

FaST™ SUPPLY HOSE CONNECTOR

The FaST™ supply hose connector is located below the FaST™ PAK holder. Soak the connector in warm water if detergent buildup is visible. When a FaST™ PAK carton is not installed, store the supply hose connector on the storing plug to prevent the hose from clogging.

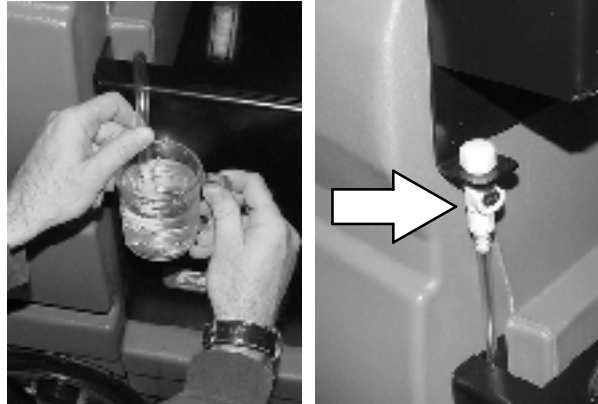

FaST™ SYSTEM FILTER SCREEN

The FaST™ system filter screen is located under the machine. It filters the water from the solution tank as it flows into the FaST™ system.

Remove the filter screen bowl and clean the filter screen after every 50 hours of FaST™ scrubbing. Empty the solution tank before removing the filter.

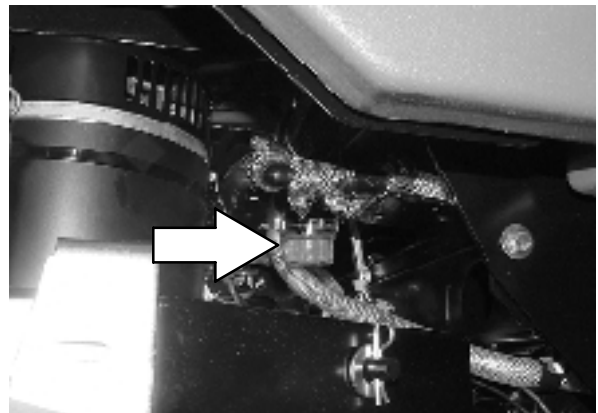

FaST™ SYSTEM AIR PUMP FILTER

The FaST™ system air pump filter is located under the machine on the air pump.

Remove and clean out the air filter with compressed air after every 200 hours of FaST scrubbing.

FOR SAFETY: When servicing machine, stop on level surface, wear eye protection when using pressurized air.

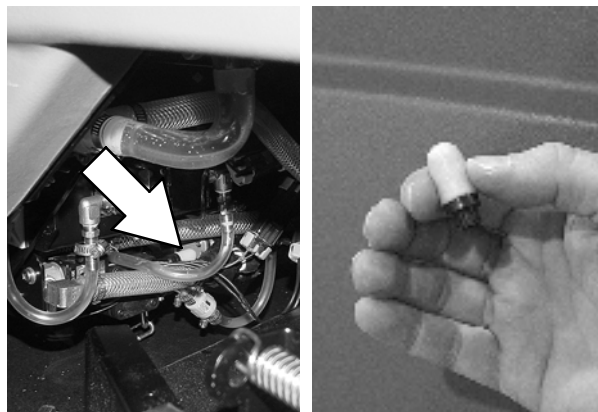

REAR SQUEEGEE ASSEMBLY

The squeegee assembly channels water into the vacuum fan suction. The front blade channels the water, and the rear blade wipes the floor.

Check the squeegee blades for damage and wear daily. Rotate or replace either of the squeegee blades if the leading edge is torn or worn half-way through the thickness of the blade.

The squeegee can be adjusted for leveling and deflection. The deflection and leveling of the squeegee blades should be checked daily, or when scrubbing a different type of floor.

The squeegee assembly can be removed from the squeegee pivot to prevent damage during transport of the machine.

REMOVING THE REAR SQUEEGEE ASSEMBLY

1. Lower the squeegee to approximately 25 mm (1 in) from the floor.
2. Turn the machine power off and set the parking brake.
3. Remove the squeegee suction hose from the squeegee.

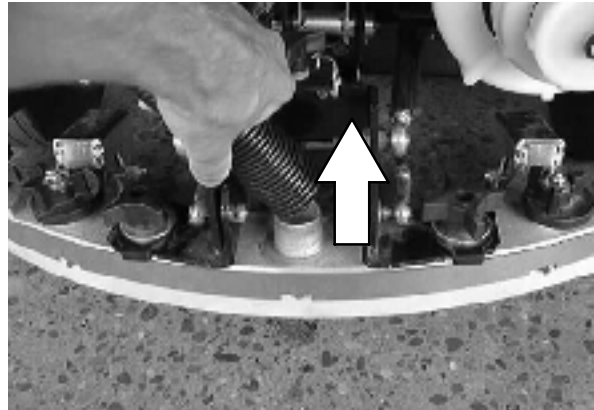

4. Remove both squeegee mounting knobs.
5. Pull the squeegee off the machine.

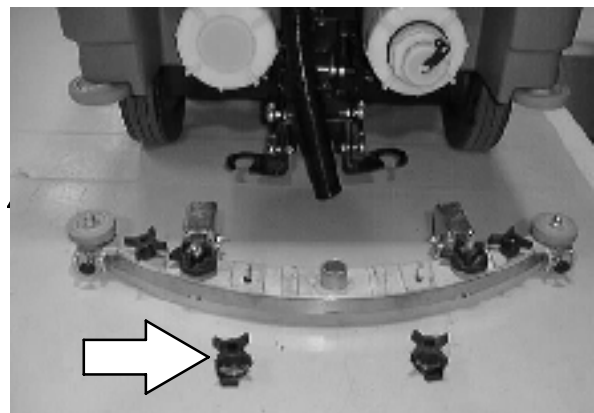

REPLACING THE REAR SQUEEGEE ASSEMBLY

1. Make sure the squeegee pivot is lowered.
2. Place the squeegee under the squeegee pivot.
3. Push the squeegee frame onto the squeegee pivot.
4. Tighten the mounting knobs.
5. Push the squeegee suction hose onto the squeegee fitting.

LEVELING THE REAR SQUEEGEE

Leveling of the squeegee assures even contact the length of the squeegee blade with the surface being scrubbed. Make sure this adjustment is done on an even, level floor.

1. Turn the machine power on.
2. Lower the squeegee.
3. Drive the machine forward a few feet, then set the parking brake.
4. Look at the deflection of the squeegee over the full length of the squeegee blade.
5. If the deflection is not the same over the full length of the blade, turn the squeegee leveling knob to make adjustments.

The squeegee leveling knob is located directly behind the squeegee suction hose. **DO NOT** disconnect the suction hose from the squeegee frame when leveling squeegee.

Turn the squeegee leveling knob counter-clockwise to increase the deflection at the ends of the squeegee.

Turn the squeegee leveling knob clockwise to decrease the deflection at the ends of the squeegee blade.

6. Drive the machine forward with the squeegee down to check the squeegee blade deflection.
7. Readjust the squeegee blade deflection if necessary.

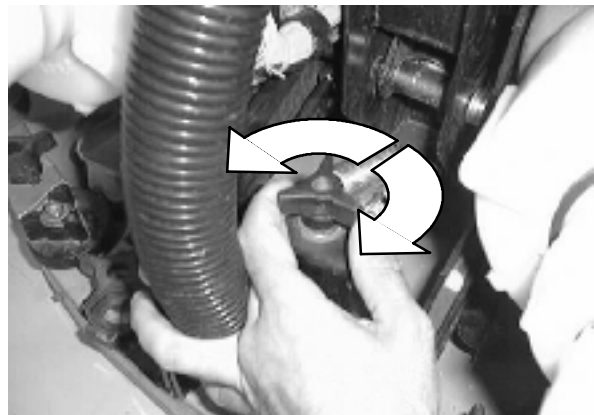

ADJUSTING REAR SQUEEGEE BLADE DEFLECTION

Deflection is the amount of curl the squeegee blade has when the machine moves forward while the squeegee lowered to the floor. The best deflection is when the squeegee wipes the floor just dry with a minimum amount of deflection.

1. Turn the machine power on.
2. Lower the squeegee.
3. Drive the machine forward, and look at the deflection of the squeegee blade. The correct amount of deflection is 12 mm (0.50 in) for scrubbing smooth floors and 15 mm (0.62 in) for rough floors.

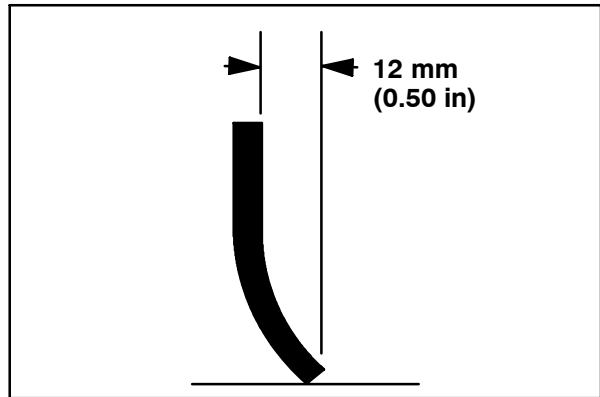

03719

4. Turn the machine power off.
5. To adjust the amount of deflection, turn the squeegee deflection cams clockwise to decrease the blade deflection.

Turn the squeegee deflection cams counter-clockwise to increase blade deflection.

6. Drive the machine forward again to check the squeegee blade deflection.
7. Readjust the squeegee blade deflection if necessary.

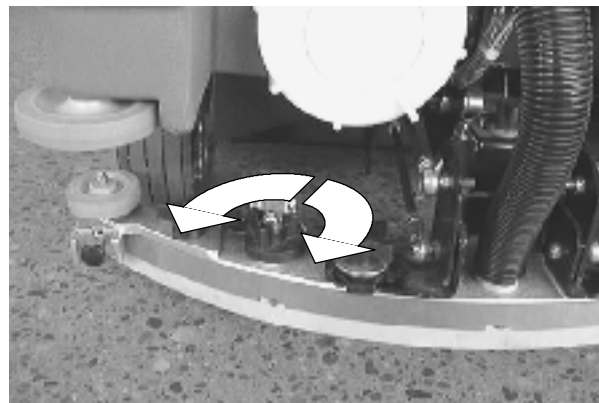

MAINTENANCE

ADJUSTING THE SQUEEGEE GUIDE ROLLER

The squeegee guide rollers are located on both ends of the rear squeegee. The rollers guide the squeegee blade end along a wall. Loosen the nut at the top of the guide roller and move the roller in or out to adjust how close the end of the squeegee blade is to the wall. The squeegee blade end should be further away from the wall when the floor curves up into the wall.

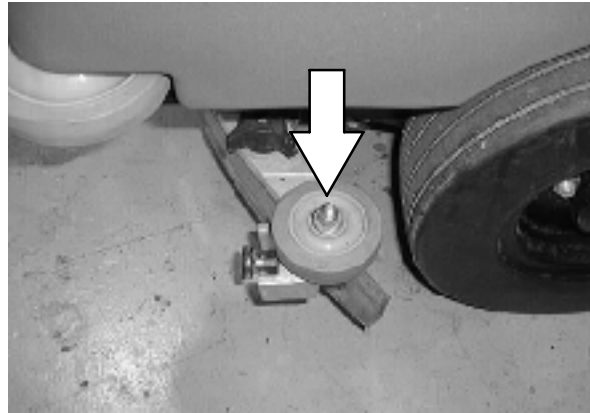

REAR SQUEEGEE BLADES

The rear squeegee has two squeegee blades, the front and rear. Each blade has four wiping edges. To use them all, start with one wiping edge. To use the next wiping edge, rotate the blade end-for-end. To use the next wiping edge, rotate the top edges down, bottom edges up. To use the last edge, rotate the blade end-for-end. Rotate squeegee blades when they become worn half-way through the thickness of the blade.

Replace damaged squeegee blades.

REPLACING OR ROTATING THE REAR SQUEEGEE BLADE

1. Make sure the squeegee is raised off the floor.
2. Turn the machine power off and set the parking brake.

FOR SAFETY: Before leaving or servicing machine, stop on level surface, set parking brake, turn off machine, and remove key.

3. Loosen the two retainer knobs, one at each end of the squeegee.

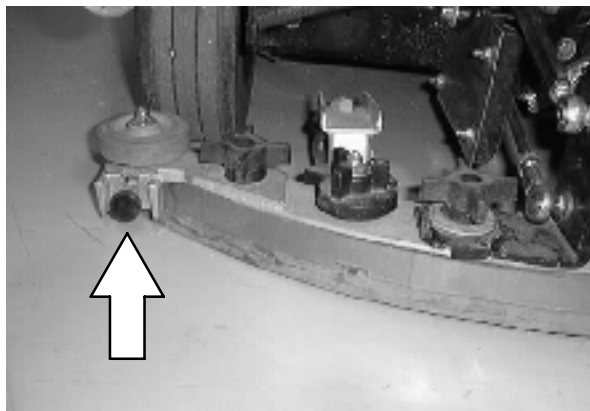

4. Pull off the retaining band.

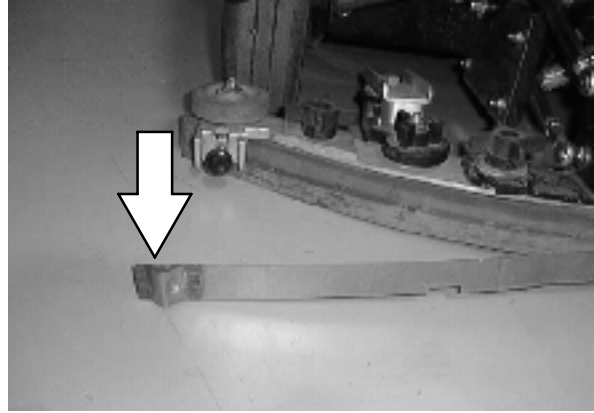

5. Pull off the rear squeegee blade.
6. Insert the rotated or new squeegee blade and then insert the retainer band.
7. Tighten the two retainer knobs until the ends of the front and rear squeegee blades touch. Do not over-tighten.

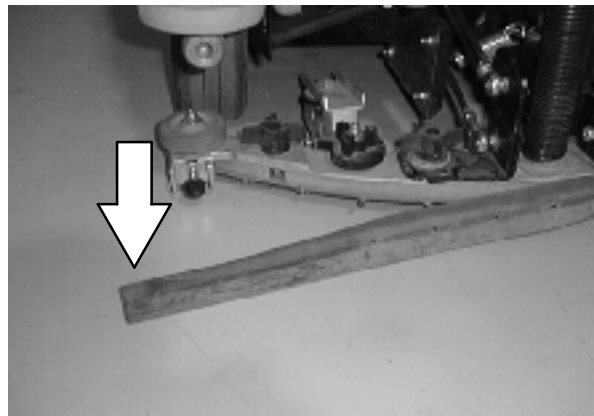

REPLACING OR ROTATING THE FRONT SQUEEGEE BLADE

1. Make sure the squeegee is raised off the floor.
2. Turn the machine power off and set the parking brake.

FOR SAFETY: Before leaving or servicing machine, stop on level surface, and turn off machine.

3. Remove the squeegee from the machine. See *REMOVING THE REAR SQUEEGEE ASSEMBLY*.
4. Remove the rear squeegee blade and retainer. See *REPLACING OR ROTATING THE REAR SQUEEGEE BLADE*.
5. Loosen the two remaining knobs on top of the squeegee assembly.
6. Pull the retainer plate back and pull out the front squeegee blade of the squeegee frame.
7. Insert the rotated or new squeegee blade in the squeegee frame, lining up the slots in the blade with the tabs on the retainer plate.
8. Push the retainer plate forward. Tighten the two outside knobs on top of the squeegee assembly.
9. Insert the rear squeegee blade and retainer. Tighten the two rear blade retainer knobs until the ends of the front and rear squeegee blades touch. Do not over-tighten.
10. Install the squeegee assembly on the squeegee pivot. See *REPLACING THE SQUEEGEE ASSEMBLY*.
11. Adjust the squeegee blade leveling and deflection as stated in *LEVELING THE REAR SQUEEGEE* and *ADJUSTING REAR SQUEEGEE BLADE DEFLECTION*.

SIDE SQUEEGEE BLADES

The side squeegees control water spray and channel water into the path of the rear squeegee. Check the side squeegees for damage and wear daily.

Replace the side squeegee blades if they become damaged or lose their shape. Replace the squeegee deflectors if they become worn.

REPLACING SIDE SQUEEGEE BLADES

1. Raise the scrub head.
2. Turn the machine power off and set the parking brake.

FOR SAFETY: Before leaving or servicing machine, stop on level surface, set parking brake, turn off machine, and remove key.

3. Remove the cotter pin, clevis pin, deflector and the retainer bracket from the side squeegee and slide the squeegee out of the frame.
4. Slide a new squeegee blade into the frame.
5. Replace the retainer bracket, deflector, clevis pin, and cotter pin.
6. Repeat for the side squeegee on the other side of the scrub head.

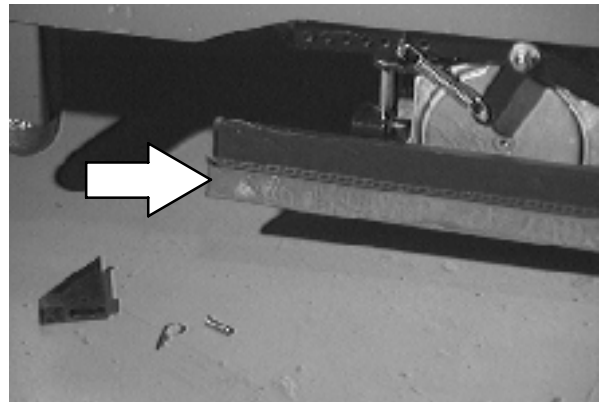

BELTS AND CHAINS

BRUSH DRIVE BELTS

The two brush drive belts are located on the cylindrical brush scrub head. The belts drive the cylindrical brushes. Proper belt tension is a 3 mm (0.1 in) deflection from a force of 1.1 to 1.2 kg (2.5 to 2.7 lb) at the belt midpoint.

Check and adjust the belt tension every 100 hours of operation.

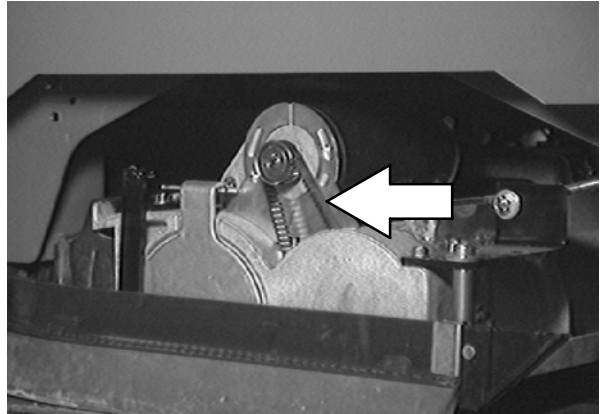

STATIC DRAG CHAIN

The static drag chain prevents the buildup of static electricity in the machine. The chain is attached to the machine frame.

Make sure the chain is always touching the floor.

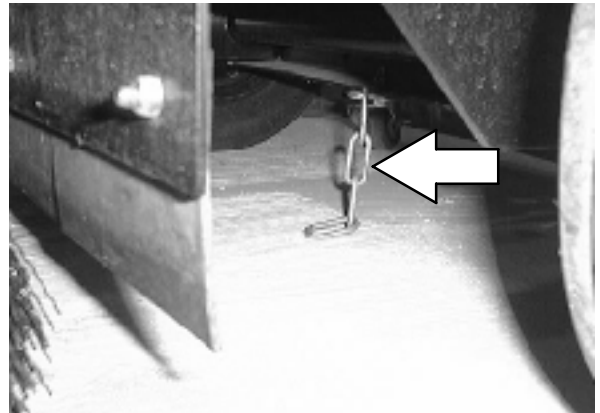

STEERING GEAR CHAIN

The steering gear chain is located directly above the front tire.

The steering gear chain tension should be checked after the first 50 hours of operation and every 500 hours thereafter. The proper deflection should be 3 to 6 mm (0.1 to 0.3 in) between the steering sprocket and the idler sprocket when the steering wheel is turned as far as it will go in either direction.

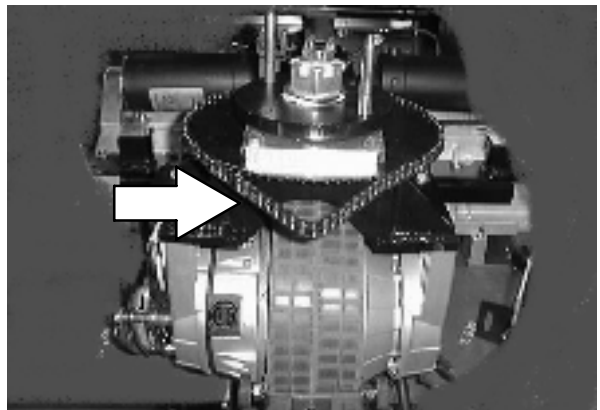

SKIRTS AND SEALS

SCRUB HEAD FLOOR SKIRTS

The skirts are located in front and rear of the disc brush scrub heads. Check the skirts for damage and wear every 50 hours of operation.

The skirts should clear the floor by 0 to 6 mm when the scrub brushes are new, and the scrub head is down.

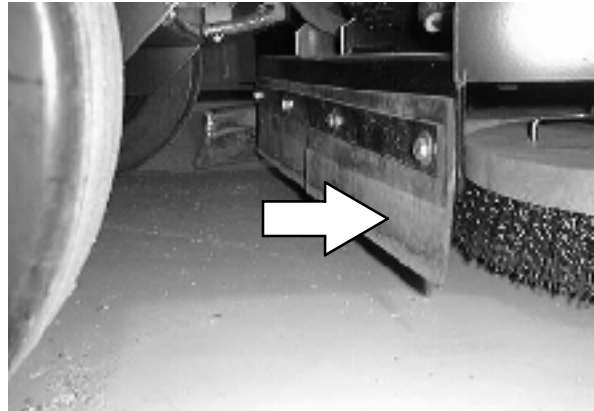
**VACUUM FAN SEAL**

The vacuum fan seal is located on top of the vacuum fan under the tank cover.

Check the seal for damage and wear after every 100 hours of operation.

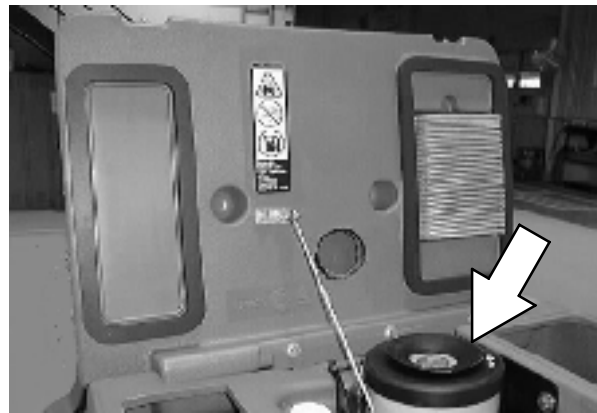

MAINTENANCE

SOLUTION TANK SEAL

The solution tank seal is located around the opening above the solution tank, under the tank cover.

Check the seal for damage and wear after every 100 hours of operation.

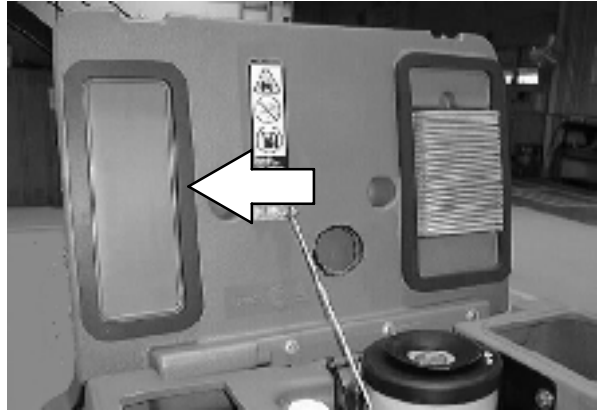

RECOVERY TANK SEAL

The recovery tank seal is located around the filter, under the tank cover.

Check the seal for damage and wear after every 100 hours of operation.

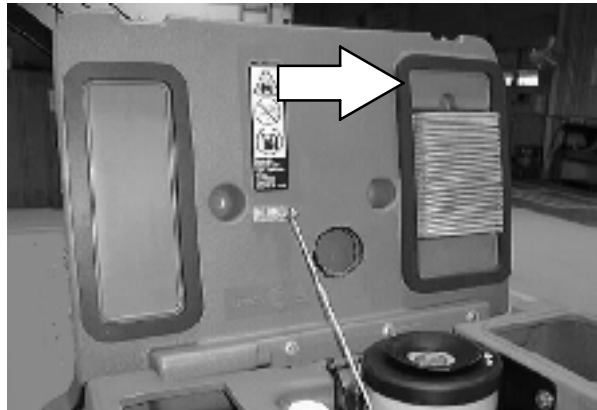

BRAKES AND TIRES

BRAKES

The mechanical brake is located on the front wheel. The *brake* is operated by the *brake pedal*.

Check the brake adjustment after every 200 hours of operation. If the brake does not respond well to pressure on the brake pedal, you may need to adjust the brake.



BRAKE ADJUSTMENT:

Remove the cotter key from the brake extension arm, and position the extension arm in the next adjustment hole in the brake link.

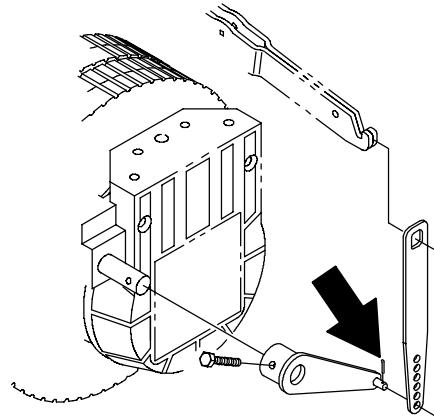

Insert the cotter key back into the brake extension arm, and check the brake for proper operation.

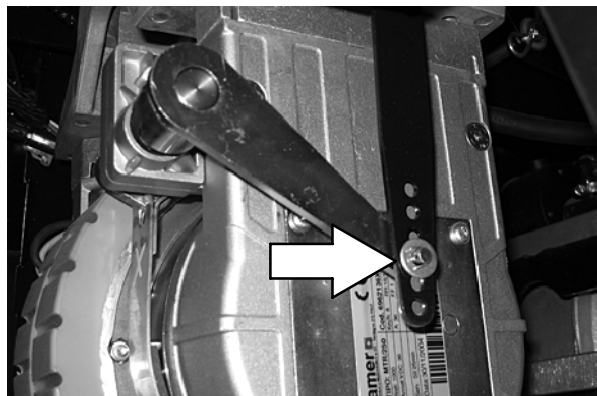

TIRES

The machine has three tires: one in front, and two in the rear of the machine. All three tires are solid rubber. Check the tires for damage and wear after every 100 hours of operation.



PUSHING, TOWING, AND TRANSPORTING THE MACHINE

PUSHING OR TOWING THE MACHINE

If the machine becomes disabled, it can be pushed from the front or rear, but only tow it from the front.

Only push or tow the machine for a *very short distance* and do not exceed 3.2 kp/h (2 mph). It is NOT intended to be pushed or towed for a long distance or at a high speed.

ATTENTION! Do not push or tow machine for a long distance or damage may occur to the propelling system.

TRANSPORTING THE MACHINE

1. Position the front of the machine at the loading edge of the truck or trailer.

FOR SAFETY: Use a truck or trailer that will support the weight of the machine.

NOTE: Empty the recovery and solution tanks before transporting the machine.

2. If the loading surface is not horizontal or is higher than 380 mm (15 in) from the ground, use a winch to load machine.

If the loading surface is horizontal AND is 380 mm (15 in) or less from the ground, the machine may be driven onto the truck or trailer.

3. To winch the machine onto the truck or trailer, attach the winching chains to the front tie down locations. The front tie-down locations are on the front sides of the machine. Make sure the machine is centered.

FOR SAFETY: When loading machine onto truck or trailer, use winch. Do not drive the machine onto the truck or trailer unless the loading surface is horizontal AND is 380 mm (15 in) or less from the ground.

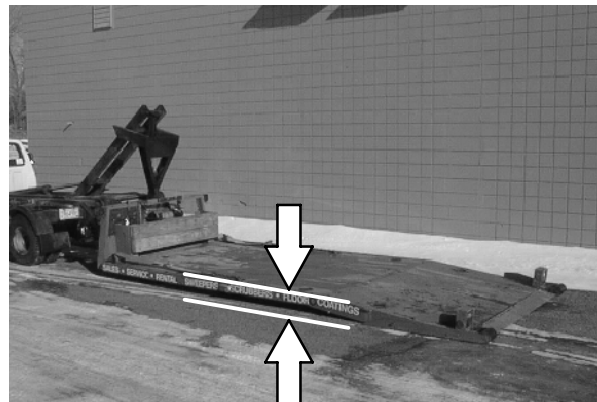

MAINTENANCE

4. Position the machine onto the truck or trailer as far as possible. If the machine starts to veer off the centerline of the truck or trailer, stop and turn the steering wheel to center the machine.
5. Set the parking brake, lower the scrub head and block the machine tires. Tie down the machine to the truck or trailer before transporting.

The front tie-down locations are on the front jack supports.

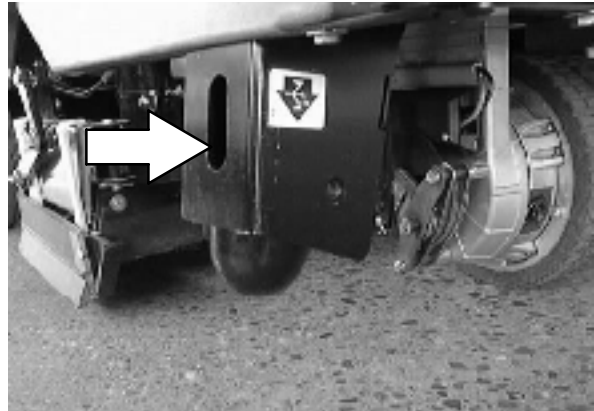

The rear tie-down locations are on the rear corners of the machine.

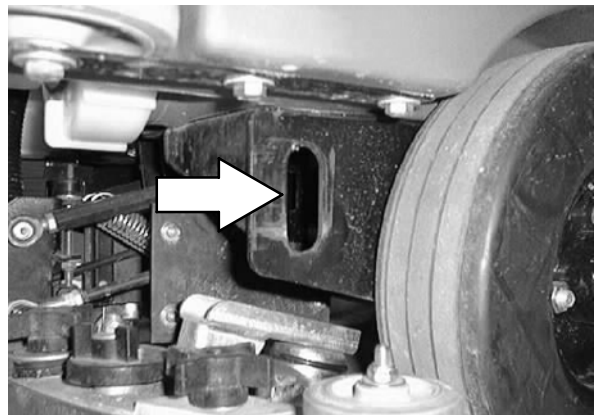

6. If the loading surface is not horizontal or is higher than 380 mm (15 in) from the ground, use a winch to unload machine.

If the loading surface is horizontal AND is 380 mm (15 in) or less from the ground, the machine may be driven off the truck or trailer.

FOR SAFETY: When unloading machine off truck or trailer, use winch. Do not drive the machine off the truck or trailer unless the loading surface is horizontal AND 380 mm (15 in) or less from the ground.

MACHINE JACKING

Empty the recovery and solution tanks before jacking the machine. You can jack up the machine for service at the designated locations. Use a hoist or jack that will support the weight of the machine. Always stop the machine on a flat, level surface and block the tires before jacking up the machine.

The front jacking locations are located on both sides of the machine, behind the sweeping assembly.

FOR SAFETY: Before leaving or servicing machine, stop on level surface, set parking brake.

FOR SAFETY: When servicing machine, use a hoist or jack that will support the weight of the machine.

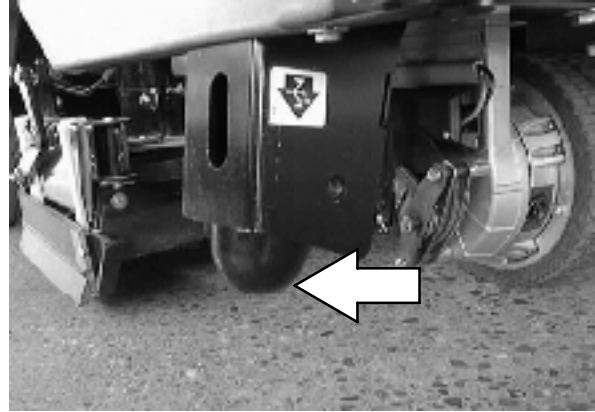

Jack up the rear of the machine from underneath the rear corners. Use a piece of wood between the jack and the frame to distribute the machine weight load.

FOR SAFETY: When servicing machine, block machine tires before jacking machine up.

FOR SAFETY: When servicing machine, jack machine up at designated locations only. Block machine up with jack stands.

STORAGE INFORMATION

The following steps should be taken when storing the machine for extended periods of time.

1. Drain and clean the solution and recovery tanks.

ES™ machines: Run clean water through the solution system and the ES™ solution pump.
2. Park the machine in a cool, dry area.
3. Remove the batteries, or charge them every three months.

FREEZE PROTECTION

1. Be sure the solution tank is empty.
2. Pour 3.8 L (1 gal) of pre-mixed automotive-type windshield washer solution into the solution tank.
3. Turn the machine power on.
4. Start the solution flow. Start the power wand solution system and ES™ system to circulate the washer solution through the components.
5. The washer solution does not need to be drained from the solution tank.

SPECIFICATIONS

GENERAL MACHINE DIMENSIONS/CAPACITIES

Item	Dimension/capacity
Length	1690 mm (66.5 in)
Width (less squeegee)	820 mm (32.25 in)
Width (with squeegee)	850 mm (33.5 in)
Height	1372 mm (54 in)
Height with overhead guard	NA
Disk brush diameter for 700 mm (28 in) scrub head	355 mm (14 in)
Disk brush diameter for 800 mm (32 in) scrub head	400 mm (16 in)
Cylindrical brush diameter	150 mm (6 in)
Cylindrical brush length for 700 mm (28 in) scrub head	700 mm (28 in)
Cylindrical brush length for 800 mm (32 in) scrub head	800 mm (32 in)
Squeegee width for 700 mm (28 in) scrub head	850 mm (33.5 in)
Squeegee width for 800 mm (32 in) scrub head	1015 mm (40 in)
Scrubbing path width for 700 mm (28 in) scrub head	700 mm (28 in)
Scrubbing path width for 800 mm (32 in) scrub head	800 mm (32 in)
Solution tank capacity	130 L (30 gallons)
Recovery tank capacity	130 L (30 gallons)
Weight/net less batteries	387 Kg (853 lbs)
Weight/with standard battery package	583 Kg (1285 lbs)
GVWR	930 Kg (2050 lbs)

GENERAL MACHINE PERFORMANCE

Item	Measure
Aisle turnaround width	1840 mm (72.5 in)
Travel Speed	9.6 Km (6 mph) 9.6 km/h (4.5 mph)
Maximum rated climb and descent angle with full tanks	4°
Maximum rated climb and descent angle with empty tanks	11°

SPECIFICATIONS

POWER TYPE

Type	Quantity	Volts	Ah Rating	Weight
Batteries	6	6	244 @ 20 hr rate	32 kg (72 lb)

Type	Use	VDC	kW (hp)
Electric Motors	Scrub brush (disk, std.)	36	0.37 (0.50)
	Scrub brush (disk, heavy duty)	36	0.60 (0.80)
	Scrub brush (cylindrical)	36	0.56 (0.75)
	Vacuum fan	36	0.6 (0.8)
	Propelling	36	1.2 (1.6)

Type	VDC	amp	Hz	Phase	VAC
Chargers (Smart)	36	25	60	1	120
	36	25	50	1	230
	36	30	50	1	245

TIRES

Location	Type	Size
Front (1)	Solid	90 mm wide x 300 mm OD (3.5 in wide x 11.8 in OD)
Rear (2)	Solid	90 mm wide x 310 mm OD (3.5 in wide x 12.3 in OD)

FaST™ SYSTEM (OPTION)

Item	Measure
Solution pump	36 Volt DC, 5A, 5.7 LPM (1.5 GPM) open flow, 45 psi bypass setting
Solution flow rate	1.1 LPM (0.30 GPM)
Detergent Pump	36 Volt DC
Detergent to water dilution ratio	1:1000
Detergent flow rate	1.35 CC/Minute (0.046 Ounces/Minute)
Air pump	36 Volt DC, 0.6 Maximum Amp Draw
Air pump flow rate	8.7 LPM (0.3 CFM) open flow

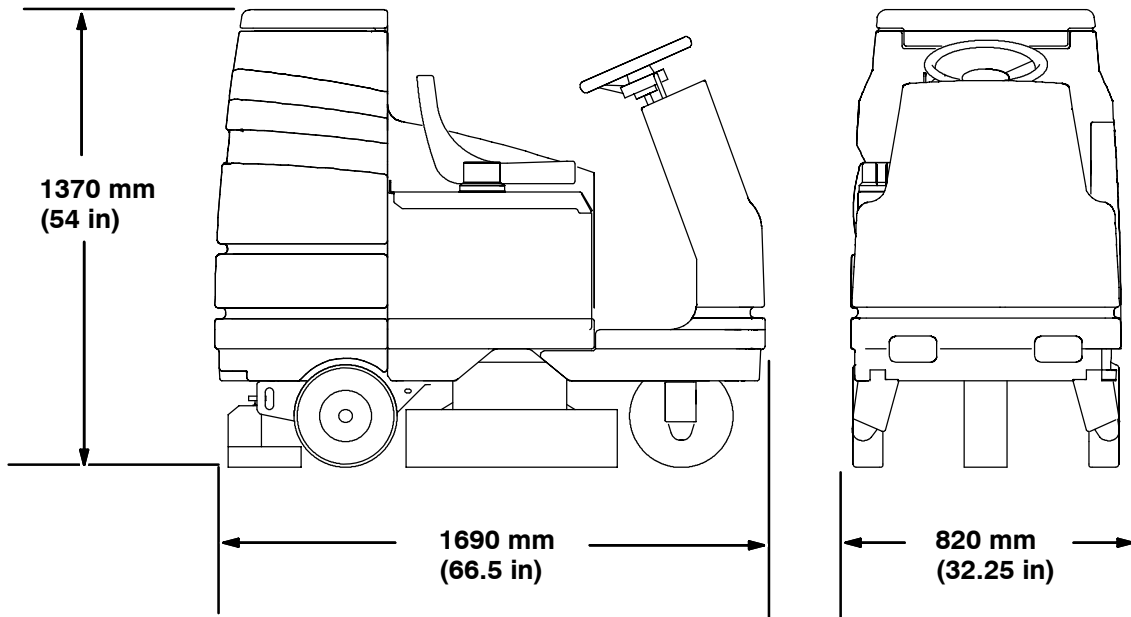
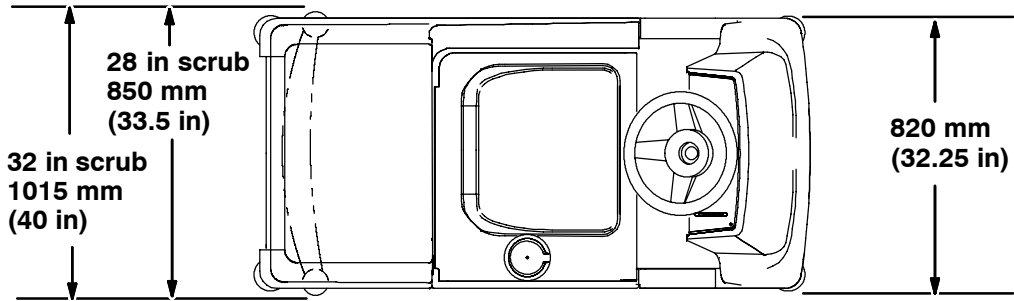

353475

MACHINE DIMENSIONS

B

- Batteries, 55
 - Charging the batteries, 57
 - Checking electrolyte level, 57
 - Maintenance, 55
 - Measuring specific gravity, 56
 - Rollout Battery, 45
 - Specifications, 88
- Battery discharge indicator, 16
- Belts, Brush drive belts, 78
- Belts and chains, 78, 79
- Brake pedal, 9
- Brushes
 - information, recommendations, 27
 - Scrubbing, 27

C

- Capacities, 87
- Chain, static drag, 78
- Chain, steering gear, 78
- Circuit breakers, 17
- Control panel, 13, 15
 - Rear squeegee switch, 14
 - Self-diagnostic test, 58
 - Symbols, 7
- Controls
 - Battery discharge indicator, 16
 - Brake pedal, 9
 - Circuit breakers, 17
 - Directional pedal, 9
 - ES switch (option), 14
 - FaST switch, 15
 - Fuse, 17
 - Horn button, 12
 - Hourmeter, 11
 - On-off key switch, 11
 - Operating lights switch, 12
 - Operation of controls, 9
 - Parking brake pedal, 9
 - Power kill switch, 11
 - Power wand switch (option), 12
 - Rear squeegee switch, 14
 - Recovery tank full indicator, 15
 - Scrub switch, 13
 - Solution flow lever, 18
 - Solution tank empty indicator, 15
 - Steering wheel, 10
- Controls and instruments, 8
- Cylindrical brushes
 - Checking and adjusting brush pattern, 64–66
 - Replacing brushes, 67

D

- Debris trough, 22, 37, 39
- Diagnostics, Self-Diagnostic test, 58
- Dimensions, 87
- Directional pedal, 9
- Draining and cleaning the tanks, 33–35

E

- Electric motors, 60
- Electrical system
 - Batteries, 55
 - Charging the batteries, 57
 - Circuit breakers, 17
 - Fuse, 17
- Electrolyte level, Checking, 57
- ES mode (option)
 - Draining and cleaning tank, 34, 35
 - ES switch, 14
- ES switch (option), 14

F

- FaST, 23
- FaST Scrubbing System, 21
- FaST Supply Hose Connector, 70
- FaST switch, 15
- FaST System, 70
 - Specifications, 88
- FaST System Air Pump Filter, 70
- FaST System Filter Screen, 70
- Filling the tanks, 25
- Filter
 - FaST System Air Pump Filter, 70
 - FaST System Filter Screen, 70
 - Vacuun fan inlet, 69
- Freeze protection, Storage, 86
- Fuse, 17

H

Horn button, 12
 Hourmeter, 11
 How the machine works, 20

I

Indicators
 Battery discharge, 16
 FaST Switch, 15
 Recovery tank full, 15
 Scrub brush pressure, 13
 Solution tank empty, 15
 Installing FaSt Pak Agent, 23

J

Jack points, 85
 Jacking, 85

K

Knobs, Squeegee leveling, 19

L

Levers, Solution flow lever, 18
 Lights, Operating lights switch, 12
 Lubrication, 54
 Rear squeegee casters, 54
 Scrub head lift bearings, 55
 Steering caster pivot bearing, 54
 Steering gear chain, 54

M

Machine, Jacking, 85
 Machine components, 6
 Machine dimensions, 89
 Machine operation
 Double scrubbing, 31
 How the machine works, 20
 Operation on inclines, 31
 Post-operation checklist, 39
 Pre-operation checklist, 22
 Starting the machine, 24
 Stop scrubbing, 32
 Stopping the machine, 38
 Troubleshooting, 51

Machine performance
 Aisle turnaround width, 87
 Climb and descent angles, 87

Machine specifications, 87–90

Machine tie down location, 84

Maintenance, 52–76

 Adjusting rear squeegee blade deflection, 73
 Adjusting squeegee guide rollers, 74
 Batteries, 55
 Checking electrolyte level, 57
 Belts and chains, 78, 79
 Brush drive belts, 78
 Charging batteries, 57
 Checking and adjusting brush pattern, 64–66
 Cylindrical brushes, 64
 Disk brushes, 60–65
 Electric motors, 60
 FaST, 70
 Leveling the rear squeegee, 72
 Lubrication, 54
 Rear squeegee assembly, 71–74
 Rear squeegee assembly removal, 71
 Rear squeegee assembly replacement, 72
 Rear squeegee blades, 74
 Rear squeegee rotation and replacement, 74
 Recommended, 5
 Recovery tank, 68
 Replacing cylindrical brushes, 67
 Replacing or rotating front squeegee blade, 76
 Replacing side squeegee blades, 77
 Scheduled intervals, 53
 Scrub brushes, 60–65
 Self-Diagnostic test, 58
 Side squeegee blades, 77
 Solution system, 68
 Solution tank, 69
 Vacuum fan inlet filter, 69

Maintenance chart, 53

Motors, Electric motors, 60

O

On-off key switch, 11
Operating lights switch, 12
Operator responsibility, 5
Operator seat, 18
 Seat support arm, 18
Options, 40–42
 Battery rollout, 55
 ES (Extended Scrub) switch, 14
 Fast, 70
 FaST Scrubbing System, 21
 FaST Switch, 15
 FaST System Specifications, 88
 Installing FaSt Pak Agent, 23
 Power wand, 40
 Power wand switch, 12
 QuickMop, 49
 Rollout Battery, 45

P

Parking brake pedal, 9
Pedals
 Brake pedal, 9
 Directional, 9
 Parking brake pedal, 9
Post-operation checklist, 39
Power kill switch, 11
Power wand (option), 40
Power wand switch (option), 12
Pre-operation checklist, 22
Pushing machine, 83
Pushing or towing the machine, 83
Pushing, towing, and transporting machine, 83

Q

QuickMop Option, 49

R

Rear squeegee
 Adjusting blade deflection, 73
 Leveling, 72
 Rotating or replacing blades, 74
Rear squeegee assembly, 71–74
 Removal, 71
 Replacement, 72
Rear squeegee blades, 74
Rear squeegee switch, 14
Recovery tank, 68
 Draining and cleaning, 33–35
Recovery tank full indicator, 15
Replacing scrub pads, 62
Replacing the disk brushes or pads, 61
Rollout Battery (option), 45

S

Operation, QuickMop, 49
Safety
 Labels, 4
 Precautions, 3
Screen, FaST System Filter Screen, 70
Scrub brushes, 60–65
 Adjusting cylindrical brush pattern, 64–66
 Brush pressure, 13
 Checking cylindrical brush pattern, 64–66
 Cylindrical brushes, 64
 Disk brushes, 60
 Replacing cylindrical brushes, 67
Scrub brushes or pads, Disk, Replacing, 61
Scrub head, Floor skirts, 79
Scrub head floor skirts, 79
Scrub head lift bearings, 55
Scrub heads, 20
Scrub pads, 62
Scrub switch, 13
 Brush down pressure indicators, 13
 Brush pressure settings, 13
Scrubbing, 29
 Double scrubbing, 31
 Operation on inclines, 31
 Scrubbing with power wand (option), 40
 Stop scrubbing, 32–34

Scrubbing brushes, 27

Scrubbing information, 27

Scrubbing pads, 28

Seat

- Adjustment lever, 18
- Operator, 18

Seat support arm, 18

Side squeegee blades, 77

- Replacement, 77

Skirts, Scrub head floor, 79

Solution flow lever, 18

Solution system, 68

Solution tank, 69

- Draining and cleaning, 33–35
- Filling the tank, 25

Solution tank empty indicator, 15

Specifications, 87–90

- Battery chargers, 88
- Electric motors, 88
- FaST System, 88
- Machine capacities, 87
- Machine dimensions, 87
- Machine performance, 87
- Power type, 88
- Tires, 88

Squeegee

- Adjusting deflection, 19
- Adjusting guide rollers, 74
- Front blade rotation or replacement, 76
- Leveling knob, 19
- Recommended amount, 73

Squeegee leveling knob, 19

Squeegee wheel cams, 19

Starting the machine, 24

Steering wheel, 10

Storage information, 86

- Freeze protection, 86

Switches

- ES switch (option), 14
- FaST, 15
- On-off key, 11
- Operating lights switch, 12
- Power kill switch, 11
- Power wand (option), 12
- Rear squeegee, 14
- Scrub, 13

Symbols, Control panel, 7

T

Tanks

- Filling the tanks, 25
- Recovery tank, 68
- Solution tank, 69

Tie down location, 84

Tires, 81, 82

- Specifications, 88

Towing machine, 83

Transporting machine, 83

Transporting the machine, 83

Troubleshooting, 51

V

Vacuum fan inlet filter, 69

